



NetworX



NetworX™ Series

NX-4V2 Control Panel

Installation and Startup

These instructions do not purport to cover all details or variations in equipment nor to provide every possible contingency to be met during installation, operation, and maintenance. If further information is desired or if particular problems arise that are not covered sufficiently for the purchaser's purpose, the matter should be referred to GE Security.

This document contains proprietary information of GE Security and is furnished to its customer solely to assist that customer in the installation, testing, operations, and/or maintenance of the equipment described. This document shall not be reproduced in whole or in part nor shall its contents be disclosed to any third party without the written approval of GE Security.

Please refer to the current GE Security product catalog for detailed warranty information.

Main	800-727-2339	Technical Support	888-437-3287
Outside the US	903-845-6941	Sales & Literature	800-547-2556
Main Fax	903-845-6811		
Web:	www.gesecurity.com		

SAFETY SYMBOLS



Warning

Indicates a procedure, practice, condition, or statement that, if not strictly observed, could result in personal injury.

* This symbol indicates electrical warnings and cautions.



Caution

Indicates a procedure, practice, condition, or statement that, if not strictly observed, could result in damage to or destruction of equipment or property.

** This symbol indicates general warnings and cautions.



Note

Indicates an essential or important procedure, instruction, condition, or statement.



Tip

Indicates a user tip. Provides helpful information that is not normally defined in regular use, but from an experienced user.

Table of Contents

I.	GENERAL DESCRIPTION.....	4
II.	ORDERING INFORMATION	4
III.	BOARD INSTALLATION.....	4
IV.	WIRING DIAGRAM.....	5
V.	TERMINAL DESCRIPTIONS	6
	NETWORX KEYPAD MAXIMUM WIRE RUN.....	6
VI.	PROGRAMMING THE LED KEYPADS	7
	KEYPAD ADDRESS	7
	CHANGING USER CODES:	7
	ASSIGNING AUTHORITY LEVEL:.....	7
VII.	PROGRAMMING THE CONTROL	8
	ENTERING THE PROGRAM MODE.....	8
	SELECTING THE MODULE TO PROGRAM.....	8
	PROGRAMMING A LOCATION	8
	EXITING A LOCATION	8
	EXITING THE PROGRAM MODE.....	8
VIII.	PROGRAMMING DATA TYPES.....	9
	NUMERICAL DATA	9
	FEATURE SELECTION DATA	9
	PROGRAMMING EXAMPLES.....	10
IX.	LOADING FACTORY DEFAULTS	11
X.	ENROLLING MODULES AND KEYPADS.....	11
XI.	 QUICK START INSTALLATION	11
XII.	PROGRAMMING LOCATIONS.....	11
	REPORTING EVENTS TO PHONE NUMBER 1	12
	REPORTING EVENTS TO PHONE NUMBER 2.....	13
	REPORTING EVENTS TO PHONE NUMBER 3.....	14
XIII.	DEFAULT ZONE TYPES (CONFIGURATIONS)	16
XIV.	PROGRAMMING WORKSHEETS	28
XV.	GLOSSARY.....	35
XVI.	APPENDIX 1.....	39
XVII.	APPENDIX 2.....	40
XVIII.	APPENDIX 3	41
XIX.	APPENDIX 4.....	41
XX.	LOCAL TELEPHONE COMPANY INTERFACE INFORMATION.....	42
XXI.	INDUSTRY CANADA INFORMATION	42
XXII.	NOTICES.....	43
XXIII.	UNDERWRITERS LABORATORIES INFORMATION.....	44
XXIV.	ANSI / SIA CP-01 REQUIREMENTS.....	46
XXV.	SPECIFICATIONS.....	48

I. GENERAL DESCRIPTION

The NetworX NX-4V2 represents a new approach to security systems design. Drawing on our experience in the world market as the largest exporter of USA manufactured controls, we have developed the most flexible, durable, and user-friendly control ever seen in our industry. Featuring sophisticated software, which allows up to 8 users to interface with 8 zones, and a host of integrated fire, access, verification, and input/output modules, all reported with the most comprehensive and fast SIA and Contact ID formats. The NetworX design allows a fully loaded system to be housed in one single metal enclosure, establishing for the first time, a logical solution and design response to modular systems. A maximum of 8 keypads and 1 other module can be added to expand the capabilities of the NX-4V2. For product warranty information, please refer to the GE Security Product Catalog.

II. ORDERING INFORMATION

PART #	DESCRIPTION	PART #	DESCRIPTION
NX-4V2	NX-4V2 Control Only	NX-508E	Eight Output Module
NX-4V2-KIT	NX-4V2 Control, NX-108E LCD Keypad, 16.5V 40VA Transformer	NX-534E **	Two-Way Listen-In Module
NX-108E	8 Zone LED Keypad	NX-540E **	"Operator" Telephone Interface Module
NX-116E	16 Zone LED Keypad	NX-591E **	Cellemetry Interface
NX-124E	24 Zone LED Keypad	NX-1192E	192 Zone LCD Keypad
NX-148E	Alphanumeric 48 Zone LCD Keypad	NX-1208E	8 Zone LED Keypad
NX-200 **	Zone Doubling Kit (Includes 100 3.74k and 100 6.98k resistors)	NX-1248E	48 Zone LCD Keypad
NX-320E	Smart Power Supply and Buss Extender	NX-1308E	8 Zone LED Door Design Keypad
NX-408E #	8 Zone Wireless Expansion Module (UL listed part #60-904)	NX-1316E	16 Zone LED Door Design Keypad
NX-416E #	16 Zone Wireless Expansion Module (UL listed part #60-904)	NX-1324E	24 Zone LED Door Design Keypad
NX-448E #	48 Zone Wireless Expansion Module (UL listed part #60-904)	NX-1448E	48 Zone Fixed Language Icon Keypad

** These products have not been tested and approved by Underwriters Laboratories, Inc.

These wireless devices are only UL listed for residential applications.

IMPORTANT NOTES

- The maximum number of zones available is 8 regardless of the devices added. Information regarding Zone Doubling is located on page 38.
- The NX-4V2 control panel will send a trouble condition once each hour if it senses that no devices have been enrolled. This report will show "Expander Trouble" – device zero (0).

III. BOARD INSTALLATION

The metal enclosure should be installed with the door opening from the top to bottom. Refer to the diagram on the right.

Inside the can, there are four slots for board insertion, two on the top and two on the bottom of the can. These allow the PC board to be positioned vertically as shown in the diagram. When you slide the board between the grooves of the slots, make sure the terminal strip is toward the front opening (toward you) to allow for the wire connections.

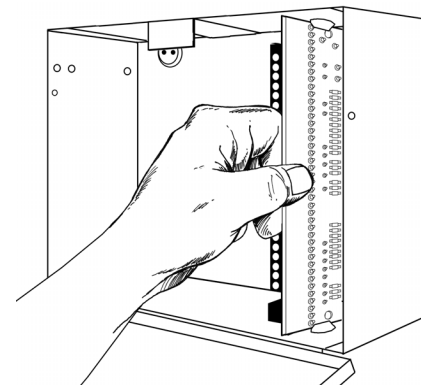

IV. WIRING DIAGRAM

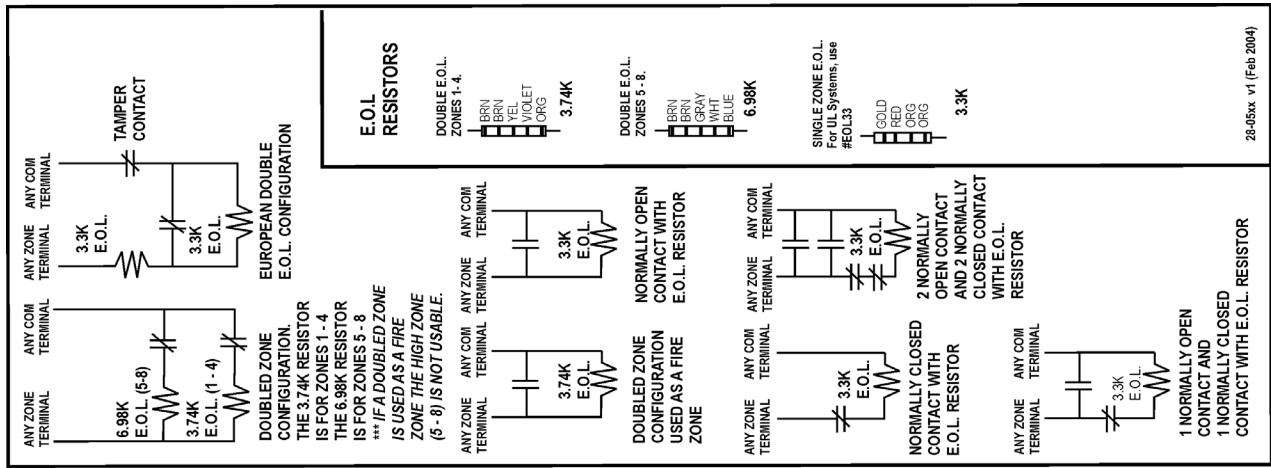

28-05xx v1 (Feb 2004)

NETWORK NX-4V2

GLADEWATER, TEXAS

SIA CP-01 CLASSIFIED MINIMUM SYSTEM REQUIREMENTS:
 ~ 1 Control Panel and 2 Keypads

This unit provides Residential fire alarm service when installed according to ANS/NFPA 72 (National Fire Protection Association, Batterymarch Park, Quincy, MA 02269) This unit provides Grade A Residential Burglar alarm service. In conjunction with the NX-003-C enclosure, this unit also provides the following Commercial Burglar alarm service: Grade A Local, Police Connect with Basic Line Security, and Grades B & C Central Station.

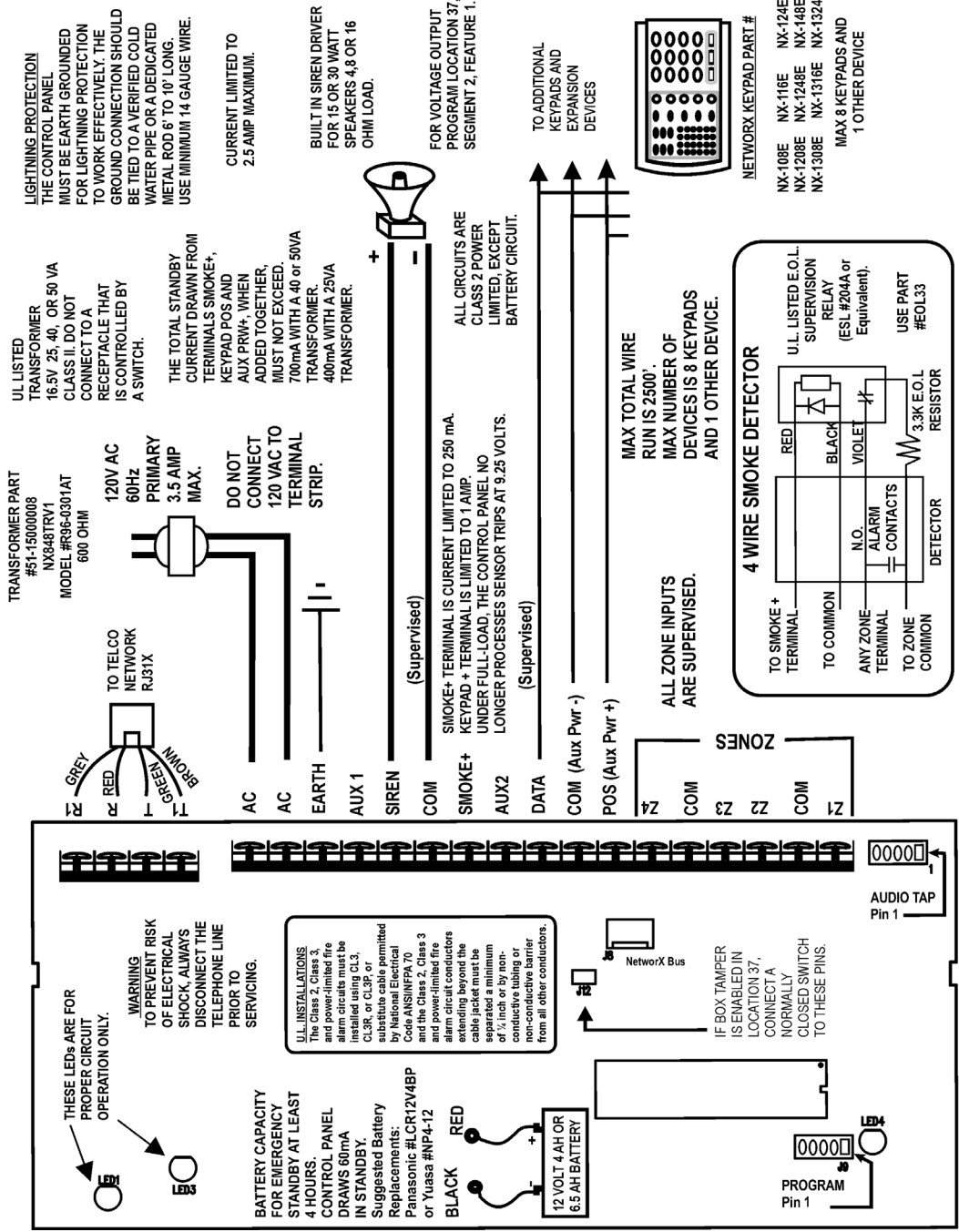

V. TERMINAL DESCRIPTIONS

TERMINAL	DESCRIPTION
R1	House Telephone Ring (Grey).
R	Telephone Ring (Red).
T	Telephone Tip (Green).
T1	House Telephone Tip (Brown).
AC	AC input. Connect to a 16.5V 40 or 50 VA Class II U.L. approved transformer.
EARTH	Earth Ground. Connect to a cold water pipe or a 6 to 10 foot driven rod.
AUX1	Connect negative lead of low current device [relay, LED (install 1K Ω resistor in series with LED), etc.]. Connect positive lead of device to COM. Current is limited to 250mA when output is negative, and 250 μ A when output is positive.
SIREN	If used as a siren output (default), the speaker rating should be 15 watt at 8 or 16 ohm, or 30/40 watt at 4, 8, or 16 ohms. If voltage output is selected in location 37, this output becomes voltage output, 12VDC, 1 Amp maximum load. NOTE: A 3.3K Ω resistor may be required across the bell terminals when a 12 VDC siren is used. If no resistor is used, you may experience voltage leakage into the siren, which will cause these devices to output a small signal.
COM	Connect negative wire of powered devices such as motion detectors and smoke detectors.
SMOKE+	Smoke detector power 12VDC, 1.5 amps maximum (For those jurisdictions which allow the Priority zone to be used with smoke detectors.)
AUX2	Connect negative lead of low current device [relay, LED (install 1K Ω resistor in series with LED), etc.]. Connect positive lead of device to COM. Current is limited to 250mA when output is negative, and 250 μ A when output is positive.
DATA	Connect to the data terminal on the keypads and the expanders. Maximum number of devices: 8 keypads + 1 other device. See "Maximum Wire Run" chart below.
COM	Connect to the Common terminal on the keypads and the expanders.
POS	Connect to the POS terminal on the keypads and the expanders. Individually, this terminal is limited to 1 Amp.
ZONE 4	Connect to one side of zone 4 loop. Connect the other side to com terminal. Open or short causes alarm.
COM	Common (-) terminal for zones 3 & 4. (See the wiring diagram for examples.)
ZONE 3	Connect to one side of zone 3 loop. Connect the other side to COM terminal. Open or short causes alarm.
ZONES 1- 2	Connect as described for zones 3 & 4

NETWORX KEYPAD MAXIMUM WIRE RUN

(Note: These numbers are for one keypad at the end of the wire. When connecting more than one keypad to the end of the wire, a higher gauge wire will be required.)

Length in feet	WHEN CONNECTED TO NX-4V2	WHEN CONNECTED TO NX320-E
	Wire Gauge	Wire Gauge
250	24	22
500	20	18
1000	18	16
1500	16	14
2500	14	12

VI. PROGRAMMING THE LED KEYPADS

KEYPAD ADDRESS

This section describes how to program the address of each keypad as well as the options that are available. The address of the keypad is important because this is how the panel supervises the keypads.

The factory default for the Master code is [1]-[2]-[3]-[4] when using a 4-digit code or [1]-[2]-[3]-[4]-[5]-[6] for a 6-digit code. The factory default for the "Go To Program" code is [9]-[7]-[1]-[3] for a 4-digit code or [9]-[7]-[1]-[3]-[0]-[0] for a 6-digit code.

[*]-[9]-[3] Set keypad options

- Enter [*]-[9]-[3] [program code]. The "Service" LED will flash.
- LEDs 1-8 can now be toggled on/off to enable/disable the following functions:
- After enabling/disabling the desired functions press [*]

LED	KEYPAD FEATURE ENABLED
1	RESERVED...DO NOT PROGRAM THIS AT ALL!
2	ENABLE SILENT KEYPAD OPTION Silences the entry/exit sounder & chime only.
3	ENABLE DING-DONG SOUND FOR CHIME If off, chime will be a single tone. (See location 40, page 19)
4	ENABLE KEYPRESS SILENCE OPTION Silences the pulsing keypad sounder for 5 seconds when a key is pressed)
5	ENABLE ARMED STATUS SUPPRESSION Will not allow the keypad to display faulted or bypassed zones when the system is armed)
6	ENABLE PANIC, FIRE, MEDICAL BEEPTONE Will sound a short beep to verify that the keypress was accepted)
7	SUPPRESSES THE "SERVICE" LED (NOTE: For UL installations, the Service LED shall not be suppressed.) Will not allow the "Service" LED to illuminate for any reason. If there is a system trouble, pressing [*]-[2] will still show the service menu.)
8	RESERVED...This LED should always be "off".

[*]-[9]-[4] Set Keypad Number

- Enter [*]-[9]-[4]-[program code]. The "Service" LED and the "Instant" LED will flash.
- Enter the keypad number (1-8)
- Press [*]. The "Instant" LED will illuminate steady and the "Service" LED will remain flashing.
- Enter [1]. The keypad will automatically exit this mode at this time.

[*]-[9]-[5] Set elapsed increments since last autotest

- Enter [*]-[9]-[5]-[program code]. The "Service" LED will flash.
- Enter [100's digit] -[10's digit]-[1's digit]-[#]

[*]-[9]-[6] Set system date

- Enter [*]-[9]-[6]-[master code]. The "Service" LED will flash.
- Enter [day of week (1=Sun)]-[month 10's digit]-[month 1's digit]-[day 10's digit] [day 1's digit] -[year 10's digit]-[year 1's digit]

[*]-[9]-[7] Set system clock

- Enter [*]-[9]-[7]-[master code]. The "Service" LED will flash.
- Enter [hour 10's digit]-[hour 1's digit]-[minutes 10's digit]-[minutes 1's digit]

CHANGING USER CODES:

- Enter [*]-[5]-[master code]. The "Ready" LED will flash.
- Enter the 2 digit user number (i.e. "03" for user 3). Maximum number of users is 8.
- Enter the new user code designated for that individual. The "Ready" LED will flash indicating that the code was accepted. If it rejects the code, the sounder will beep 3 times.
- If another user code needs to be programmed, return to step 2.
- Press [#] while the "Ready" LED is flashing to exit the User Code Programming Mode.

ASSIGNING AUTHORITY LEVEL:

- Enter [*]-[6]-[master code]. The "Ready" LED will flash.
- Enter the 2 digit user number. The "Ready" LED will illuminate steady and the "Instant" LED will flash.
- Refer to the chart below for the description of each LED. Turn the LED on for the features that you desire.

LED	ATTRIBUTES IF LED 8 IS OFF	LED	ATTRIBUTES IF LED 8 IS ON
1	Reserved	1	Activate output #1
2	Arm Only	2	Activate output # 2
3	Arm Only After Close Window	3	Activate output # 3
4	Master arm/disarm (can program other codes)	4	Activate output # 4
5	Arm/disarm code	5	Arm/disarm
6	Allowed to bypass zones (see location 23)	6	Bypass Zones
7	Code will send open / close reports	7	Open / Close Reporting
8	If this LED is on, LEDs 1-7 will use the chart to the right	8	If this LED is off, LEDs 1-7 use the chart to the left

- Enter [*] [*]. This returns you back to step 2 above, where you may enter another user number to assign attributes for. You may continue this procedure until you have assigned authority levels to all user numbers - or - you may press [#] key to exit the Assigning Authority Level Program.

[*]-[9]-[8]

- Pressing [*]-[9]-[8] while the system is disarmed will cause the control to do a callback for a download.
- **NOTE: A valid user code may be required after [*]-[9]-[8] if enabled in location 41, page 19.**

[*]-[9]-[9]

- Pressing [*]-[9]-[9] while the system is disarmed will cause the control panel to seize the phone line for a download.
- **NOTE: A valid user code may be required after [*]-[9]-[9] if enabled in location 41, page 19.**

VII. PROGRAMMING THE CONTROL

ENTERING THE PROGRAM MODE

To enter the Program Mode, press [*]-[8]. At this time, the five function LEDs (Stay, Chime, Exit, Bypass, & Cancel) will begin to flash. Next, enter the "Go To Program Code" (FACTORY DEFAULT IS [9]-[7]-[1]-[3]). If the "Go To Program Code" is valid, the "Service" LED will flash and the five function LEDs will illuminate steady. You are now in the Program Mode and ready to select the module to program.

SELECTING THE MODULE TO PROGRAM

Since all modules connected to the NX-4V2 are programmed through the keypad, the module you are programming should be the first entry. To program the NX-4V2 Control Panel, enter [0]-[#]. The [0] is the module number of the control and [#] is the entry key. Other module entry numbers can be found in their corresponding manuals.

PROGRAMMING A LOCATION

Once the number of the module to be programmed has been entered, the "Armed" LED will illuminate, indicating it is waiting for a programming location to be entered. Any location can be accessed by directly entering the desired programming location followed by [#]. If the location entered is a valid location, the "Armed" LED will extinguish, the "Ready" LED will illuminate and the binary data for the first segment of this location will be shown by the zone LED's. While entering new data, the "Ready" LED will begin flashing to indicate a data change in process. The flashing will continue until the new data is stored by pressing [*]. Upon pressing [*], the keypad will advance to the next segment and display its data. This procedure is repeated until the last segment is reached. Pressing the [#] key will exit from this location, and the "Armed" LED will illuminate again waiting for a new programming location to be entered. If the desired location is the next sequential location, press the [POLICE] key. If the previous location is desired press the [FIRE] key. If the same location is desired press the [MEDICAL] key. To review the data in a location, repeat the above procedure, pressing [*] without any numeric data entry. Each time [*] is pressed, the programming data of the next segment will be displayed for review.

EXITING A LOCATION

After the last segment of a location is programmed, pressing [*] will exit that location, turn the "Ready" LED off and the "Armed" LED on. The [*] must be pressed or the data will not be saved. To exit before the last segment, press [#]. As before, you are now ready to enter another programming location. If an attempt is made to program an invalid entry for a particular segment, the keypad sounder will emit a triple error beep (beep, beep, beep), and remain in that segment awaiting a valid entry.

EXITING THE PROGRAM MODE

When all the desired changes in programming have been made, it is time to exit the program mode. Pressing [Exit] will exit this programming level, and go to the "Select a Module To Program" level. If no additional modules are to be programmed, pressing [Exit] again will exit the program mode. If there is a module to be programmed, it may be selected by entering its address followed by [#] (see "Selecting the Module To Program" above). The procedure for programming these devices is the same as for the control panel, except the locations will be for the module selected.

VIII. PROGRAMMING DATA TYPES

Programming data is always one of two types. One type of data is numerical and can take on values from 0 to 15 or 0 to 255 depending on the location's segment. The other type of data is a feature selection type. Feature selection data is used to turn features on or off. Examples are shown on page 10. Use the following procedures when working with these two data types.

NUMERICAL DATA

Numerical data is programmed by entering a number from 0-255 on the numeric keys of the system keypad. To view the data in a location, a binary process is used. With this process, the LEDs for zones 1 through 8 are utilized, and the numeric equivalents of their illuminated LEDs are added together to determine the data in a programming location. The numeric equivalents of these LEDs are as follows:

Zone 1 LED = 1	Zone 2 LED = 2	Zone 3 LED = 4	Zone 4 LED = 8
Zone 5 LED = 16	Zone 6 LED = 32	Zone 7 LED = 64	Zone 8 LED = 128

Example: If the numerical data to be programmed in a location is "66", press [6]-[6] on the keypad. The LEDs for Zone 2 and Zone 7 will become illuminated indicating 66 is in that location (2 + 64 = 66). See this example on page 10. Once the data is programmed, press [*] to enter the data and advance to the next segment of that location. After the last segment of a location is programmed, press [*] to exit that location, turn the "Ready" LED off and the "Armed" LED on. As before, you are now ready to enter another programming location. If an attempt is made to program a number too large for a particular segment, the keypad sounder will emit a triple beep, indicating an error, and remain in that segment awaiting a valid entry. On the LCD keypad, the number in the location will be displayed. For locations with a maximum of 15, the hexadecimal equivalent will be displayed in parenthesis. Example: 11 (B) or 14 (E).

FEATURE SELECTION DATA

Feature selection data will display the current condition (on or off) of eight features associated with the programming location and segment selected. Pressing a button on the touchpad (1 thru 8) that corresponds to the "feature number" within a segment will toggle (on/off) that feature. Pressing any numeric key between [1] and [8] for selection of a feature, will make the corresponding LED illuminate (feature ON). Press the number again, and the LED will extinguish (feature OFF). You will see that numerous features can be selected from within one segment. For instance, if all eight features of a segment are desired, pressing [1]-[2]-[3]-[4]-[5]-[6]-[7]-[8] will turn on LED's 1 thru 8 as you press the keys, indicating that those features are enabled. **LCD Keypad Note:** The numbers of the enabled features will be displayed. However, the features not enabled will display a hyphen (-). After the desired setting of features is selected for this segment, press [*]. This will enter the data and automatically advance to the next segment of the location. When you are in the last segment of a location and press [*] to enter the data, you will exit that location. This will now turn the "Ready" LED off and the "Armed" LED on. As before, you are now ready to enter another programming location.

PROGRAMMING EXAMPLES

FIGURE1 (Numerical Data)



Zone 1 LED = 1
Zone 4 LED = 8 } Data = 9



Zone 2 LED = 2
Zone 7 LED = 64 } Data = 66

To change data in a segment, enter the data followed by [*]

Pressing [#] will exit a location without changing the data in the current segment.

Enters the previous programming "location".

Returns to the "location" just programmed.

Advances to the next programming "location".



FIGURE 2 (Feature Selection Data)

Location 23 • Segment 1

- 1 = Quick Arm
- 2 = Re-Exit
- 3 = Auto Bypass
- 4 = Silent Keypad Panic
- 5 = Audible Keypad Panic
- 6 = Keypad Auxiliary 1
- 7 = Keypad Auxiliary 2
- 8 = Multi-Keypad Tamper



Press the key on the numeric keypad that corresponds to the feature you wish to enable/disable. When an LED is "on", a feature is enabled; when "off" the feature is disabled. For example: With the 1, 5, & 7 LEDs "on", Quick Arm, Audible Keypad Panic and Keypad Auxiliary 2 are enabled.

IX. LOADING FACTORY DEFAULTS

To load the factory defaults, enter the program mode using the procedure on page 8, then type [9]-[1]-[0]-[#]. The keypad will beep 3 times indicating that the loading is in progress. The loading takes about 6 seconds.

X. ENROLLING MODULES AND KEYPADS

For supervision purposes, the NX-4V2 has the ability to automatically find and store in its memory, the presence of all keypads, zone expanders, wireless receivers, and any other module connected to the data terminal. This allows these modules to be supervised by the control panel. To enroll the modules, enter the Program Mode of the NX-4V2 control panel as described on page 8. When the Program Mode is exited, the NX-4V2 control will automatically enroll the devices. The enrolling process takes about 12 seconds, during which time the "Service" LED will illuminate. User codes will not be accepted during the enrolling process. If a speaker is attached to the NX-4V2, it will click at this time. If a siren or bell is attached to the NX-4V2, it will sound for about 1 second. Once a module is enrolled, if it is not detected by the control, the "Service" LED will illuminate.

XI. QUICK START INSTALLATION

For most routine installations, the "Quick Start" option will allow for enabling a majority of the options available with the NX-4V2, when communicating in Contact ID or SIA formats. The "Quick Start" locations can be identified by the  symbol.

XII. PROGRAMMING LOCATIONS

LOCATION	DESCRIPTION	SEGMENTS....DATA TYPE
----------	-------------	-----------------------

	0	PHONE NUMBER 1	20 numerical
	The first telephone number is programmed in location 0. A "14" indicates the end of the phone number. Delays of four seconds can be programmed at any point in the phone number by programming a "13" in the appropriate segment. If tone dialing is desired, program a "15" in the segment where tone dialing should begin. If the entire number should be tone dialing, program a "15" in the first segment. Program an "11" for a "*", and a "12" for a "#". Caution: A call-waiting cancel on a non- call waiting line will prevent successful connection to the central station.		

	1	ACCOUNT CODE FOR PHONE 1	6 numerical
	The account code sent when Phone 1 is dialed is programmed in location 1. Program a "10" in the segment immediately after the last digit of the account code. If the account code is 6 digits long, program all 6 segments.		

	2	COMMUNICATOR FORMAT FOR PHONE 1	1 numerical
	Location 2 contains the communicator format used to transmit to the receiver connected to Phone 1. Consult the instructions for your central station receiver to determine which format is compatible. Select a format from Table XII-1 COMMUNICATOR FORMAT SELECTIONS. If you require a format other than those listed, review the override options described in location 18, to build the appropriate format. A "15" must be programmed in location 2 in addition to the entries in location 18 in order to create a special format. If this location contains a "0", the built-in communicator will be disabled, and the NX-4V2 will function as a local only control.		

Table XII-1 COMMUNICATOR FORMAT SELECTIONS

DATA	FORMAT	DESCRIPTION
0	Local	Communicator is disabled
1	Universal 4+2	Two digit event code 1800hz transmit 2300hz handshake double round parity 40pps
2	3+1 fast (or 4+1)	One digit event code 1900Hz transmit 1400Hz handshake double round parity 20pps
3	Reserved	Reserved
4	Pager	2 digit event code DTMF transmission
5	3/1 or 4/1 slow	1800hz transmit 2300hz handshake double round parity 20 p.p.s. hex capability
6	3/1 or 4/1 slow	1800hz transmit 1400hz handshake double round parity 20 p.p.s. hex capability
7	3/1 or 4/1 fast	1800hz transmit 2300hz handshake double round parity 40 p.p.s. hex capability
8	3/1 or 4/1 fast	1800hz transmit 1400hz handshake double round parity 40 p.p.s. hex capability
9	3/1 or 4/1 fast with parity	1800hz transmit 2300hz handshake single round w/parity 40 p.p.s. hex capability
10	3/1 or 4/1 fast with parity	1800hz transmit 1400hz handshake single round w/parity 40 p.p.s. hex capability
11	4+2 express	2 digit event code DTMF transmission
12	4+2 fast	Two-digit event code 1900hz transmit 1400hz handshake double round parity 20 p.p.s.
13	Ademco Contact ID	DTMF (see pages 39 & 40)
14	SIA	FSK (see pages 39 & 40)
15	Custom format	(See location 18, page 14)

 **3 DIAL ATTEMPTS/BACKUP CONTROL FOR PHONE 1** **2 numerical**

Segment 1- Dial attempts: Location 3, Segment 1 is used to enter the number of dial attempts (1 to 15 Attempts) the communicator will make to Phone 1 before ending the notification process. Factory default is "8" and the communicator will make eight (8) attempts to the first number.

Segment 2- Phone 1 Backup Control: Programming a "0" in Segment 2 of this location will cause the NX-4V2 to make the designated number of attempts to Phone 2 before setting the "Fail To Communicate" condition and stop reporting. Programming a "1" in this segment will cause the NX-4V2 to stop trying to communicate after the designated number of attempts have been made to Phone 1. If a "2" is programmed in this segment, it will cause the NX-4V2 to make the dial attempts in increments of two. The first two attempts will be made to Phone 1, the next two attempts to Phone 2, then repeating until the total number of attempts designated in Segment 1 is completed.

REPORTING EVENTS TO PHONE NUMBER 1

Phone 1 has two programming locations that are used to select which events are reported to this phone number. Location 4 is used to select which events are reported to Phone 1. If dual or split reporting is not desired, location 4 should be used to select all events to Phone 1. If dual or split reporting is desired, and the split is based on the event type (such as alarm, open/close, etc.), location 4 should be used to select only those events that should be reported to Phone 1. If no events should be reported to Phone 1, location 4 should be programmed as "0" (disabling all options).

4 EVENTS REPORTED TO PHONE 1 **2 feature select**

Segment 1:

- 1 = Alarms and Alarm Restores.
- 2 = Opening and Closings.
- 3 = Zone Bypass and Bypass Restores.
- 4 = Zone Trouble and Trouble Restores.
- 5 = Power Fail, Low Battery, Power Restore, and Low Battery Restore.
- 6 = Bell Cut, Telephone Line Cut, Bell Cut Restore, Telephone Line Restore.
- 7 = Test Reports.
- 8 = Start and End programming, Download complete.

Segment 2:

- 1 = Zone and Box Tamper and Tamper Restore.
- 2 = Auxiliary Power Overcurrent, and Restore.
- 3 = Wireless Sensor Missing and Restore.
- 4 = Wireless Sensor Low Battery and Restore.
- 5 = Expander Trouble and Restore.
- 6 = Fail To Communicate.
- 7 = Zone Activity Monitor.
- 8 = Reserved.

5 RESERVED

 **6 PROGRAMMING PHONE 2** **20 numerical**

Phone 2 is programmed in location 6. A "14" indicates the end of the phone number. Delays of four seconds can be programmed at any point in the phone number by programming a "13" in the appropriate segment. If tone dialing is desired, program a "15" in the segment where tone dialing should begin. If the entire number should be tone dialing, program a "15" in the first segment. Program an "11" for a "*", and a "12" for a "#". **Caution:** A call-waiting cancel on a non-call waiting line will prevent successful connection to the central station.

 **7 ACCOUNT CODE FOR PHONE 2** **6 numerical**

The account code sent when Phone 2 is dialed is programmed in location 7. Program a "10" in the segment immediately after the last digit of the account code. If the account code is 6 digits long, program all 6 segments. If this location is left unprogrammed, account code 1 will be used when the second phone number is dialed.

 **8 COMMUNICATOR FORMAT FOR PHONE 2** **1 numerical**

Location 8 contains the communicator format used to transmit to the receiver connected to Phone 2. Consult the instruction manual for your central station receiver to determine which format is compatible, and select from Table XII-1 COMMUNICATOR FORMAT SELECTIONS on page 11. If you require a format other than those listed, review the override options described in Location 18 to build the appropriate format. A "15" must be programmed in location 8 in addition to the entries in location 18 in order to create a special format. If this location contains a "0", format 1 will be used when Phone 2 is dialed.

9**DIAL ATTEMPTS/BACKUP CONTROL FOR PHONE 2****2..... numerical**

Segment 1, Dial attempts: Segment 1 of Location 9 is used to enter the number of dial attempts (1 to 15 attempts) the communicator will make to Phone 2 before ending the notification process. Factory default is "8" and the communicator will make the same number of attempts as those programmed in location 3.

Segment 2, Phone 2 Backup Control: Programming a "0" in Segment 2 of this location will cause the NX-4V2 to make the designated number of attempts to Phone 1 before setting the "Fail To Communicate" condition and stop reporting. Programming a "1" in this segment will cause the NX-4V2 to stop trying to communicate after the designated number of attempts have been made to Phone 2. If a "2" is programmed in this segment, it will cause the NX-4V2 to make the dial attempts in increments of two. The first two attempts will be made to Phone 2, the next two attempts to Phone 1, then repeating until the total number of attempts designated in Segment 1 is completed.

REPORTING EVENTS TO PHONE NUMBER 2

Phone 2 can be used to back up Phone 1 or for a second receiver to multi-report or split report events. Location 10 is used to select which events are reported to Phone 2. If dual or split reporting is not desired, location 10 should be left at the factory default of "0". If multi-reporting or split reporting is desired, and the split is based on the event type (such as alarm, open close etc.), location 10 should be used to select only those events that should be reported to Phone 2. If no events should be reported to Phone 2, location 10 should be "0".

10**EVENTS REPORTED TO PHONE 2****2..... feature select****Segment 1:**

- 1 = Alarms and Alarm Restores.
- 2 = Opening and Closings.
- 3 = Zone Bypass and Bypass Restores.
- 4 = Zone Trouble and Trouble Restores.
- 5 = Power Fail, Low Battery, Power Restore, and Low Battery Restore.
- 6 = Bell Cut, Telephone Line Cut, Bell Cut Restore, Telephone Line Restore.
- 7 = Test Reports.
- 8 = Start and End programming, Download complete.

Segment 2:

- 1 = Zone and Box Tamper and Tamper Restore.
- 2 = Auxiliary Power Overcurrent and Restore.
- 3 = Sensor Missing and Restore.
- 4 = Sensor Low Battery and Restore.
- 5 = Expander Trouble and Restore.
- 6 = Fail To Communicate.
- 7 = Zone Activity Monitor.
- 8 = Reserved.

11**RESERVED****12****PROGRAMMING PHONE 3****20..... numerical**

Phone 3 is programmed in location 12. A "14" indicates the end of the phone number. Delays of four seconds can be programmed at any point in the phone number by programming a "13" in the appropriate segment. If tone dialing is desired, program a "15" in the segment where tone dialing should begin. If the entire number should be tone dialing, program a "15" in the first segment. Program an "11" for a "*", and a "12" for a "#". **Caution:** A call-waiting cancel on a non-call waiting line will prevent successful connection to the central station.

13**ACCOUNT CODE FOR PHONE 3****6..... numerical**

The account code sent when Phone 3 is dialed is programmed in location 13. Program a "10" in the segment immediately after the last digit of the account code. If the account code is 6 digits long, program all 6 segments. If location 6 is left unprogrammed, account code 1 will be used when the Phone 3 is dialed.

14**COMMUNICATOR FORMAT FOR PHONE 3****1..... numerical**

Location 14 contains the communicator format used to transmit to the receiver connected to phone 3. Consult the instruction manual for your central station receiver to determine which format is compatible, and select from Table XII-1 COMMUNICATOR FORMAT SELECTIONS on page 11. If you require a format other than those listed, review the override options described in Location 18 to build the appropriate format. A "15" must be programmed in location 14 in addition to the entries in location 18 in order to create a special format. If this location contains a "0", format 1 will be used when Phone 3 is dialed.

15**DIAL ATTEMPTS/BACKUP CONTROL FOR PHONE 3****2..... numerical**

Segment 1, Dial Attempts: Segment 1 of Location 15 is used to enter the number of dial attempts (1 to 15 attempts) the communicator will try to Phone 3 before ending the notification process. Factory default is "8" and the communicator will make the same number of attempts as those programmed in location 3.

Segment 2, Phone 3 Backup Control: Programming a "0" in Segment 2 of this location will cause the NX-4V2 to make the designated number of attempts to Phone 2 before setting the "Fail To Communicate" condition and stop reporting. Programming a "1" in this segment will cause the NX-4V2 to stop trying to communicate after the designated number of attempts have been made to Phone 3. If a "2" is programmed in this segment, it will cause the NX-4V2 to make the dial attempts in increments of two. The first two attempts will be made to Phone 3, the next two attempts to Phone 2, then repeating until the total number of attempts designated in Segment 1 is completed.

REPORTING EVENTS TO PHONE NUMBER 3

Phone 3 can be used for a third receiver to multi-report or split report events. Location 16 is used to select which events are reported to Phone 3. If dual or split reporting is not desired, location 16 should be left at the factory default of "0". If multi-reporting or split reporting is desired and the split is based on the event type (such as alarm, open/close, etc.), then location 16 should be used to select only those events that should be reported to Phone 3. If no events should be reported to Phone 3, location 16 should be "0".

16 EVENTS REPORTED TO PHONE 3 2 feature select

Segment 1:

- 1 = Alarms and Alarm Restores.
- 2 = Opening and Closings.
- 3 = Zone Bypass and Bypass Restores.
- 4 = Zone Trouble and Trouble Restores.
- 5 = Power Fail, Low Battery, Power Restore, and Low Battery Restore.
- 6 = Bell Cut, Telephone Line Cut, Bell Cut Restore, Telephone Line Restore.
- 7 = Test Reports.
- 8 = Start and End programming, Download complete.

Segment 2:

- 1 = Zone and Box Tamper and Tamper Restore.
- 2 = Auxiliary Power Overcurrent and Restore.
- 3 = Sensor Missing and Restore.
- 4 = Sensor Low Battery and Restore.
- 5 = Expander Trouble and Restore.
- 6 = Fail To Communicate.
- 7 = Zone Activity Monitor.
- 8 = Reserved.

17 RESERVED

18 CUSTOM COMMUNICATOR FORMAT (See loc 2, 8, &14)

Segment 1:

- 1 = On for 1800hz transmit; Off for 1900hz.
- 2 = On for 2300hz handshake; Off for 1400hz.
- 3 = On for cksum parity; Off for double round parity.
- 4 = On for 2 digit event code; Off for 1 digit event code.
- 5 = Reserved.
- 6 = Reserved.
- 7 = On for 20 p.p.s.; Off for 10 or 40 p.p.s.
- 8 = On for 10 p.p.s.; Off for 20 or 40 p.p.s.

Segment 2:

- 1 = On for pager format (no handshake required).
- 2 = On for 1400/2300 handshake.
- 3 = Reserved
- 4 = Reserved.
- 5 = On for Contact ID.
- 6 = On for SIA.
- 7 = On for Contact ID or 4+3.
- 8 = On for DTMF.

Segment 3 & 4: Reserved

19 DOWNLOAD ACCESS CODE 8 numerical

Location 19 contains the eight-digit access code the NX-4V2 must receive from the downloading software before the panel will permit downloading to occur. The factory default code is 84800000.

20 NUMBER OF RINGS TO ANSWER 1 numerical

Location 20 contains the number of rings to answer for a download. Enter a number from "0" (disabled) to "15". Factory default is "8" and the NX-4V2 will answer on 8 rings.

**21****DOWNLOAD CONTROL****1..... feature select**

Location 21 contains the feature selections for the controlling of download sessions. The following features can be enabled or disabled using this location. (Refer to Glossary beginning on page 35)

Segment 1:

- 1 = On enables two call answering machine defeat.
- 2 = On enables tone sniff answering machine defeat.
- 3 = On requires call back before download session.
- 4 = Shutdown
- 5 = On locks all local programming
- 6 = On locks programming of all locations associated with the communicator
- 7 = On locks out download section. (If "On", locations 19 - 22 cannot be viewed from the keypad; can only be viewed from the keypad when "Off".)
- 8 = On enables call back at auto test interval.

Options 4, 5, 6, and 7 can only be viewed from the keypad. These options must be changed through downloading.

**22****DOWNLOAD CALL BACK NUMBER****20..... numerical**

If a telephone number is programmed into this location, and "Require Callback" is enabled in location 21, the control panel will hang up for approximately 36 seconds (ensuring that the calling party has disconnected), and then call back. If tone dialing is desired, program an "15" in the segment where tone dialing should begin. If the entire number should be tone dialing, program an "15" in the first segment. Four-second delays can be obtained anywhere in the sequence by programming a "13" in the appropriate delay location.



THE CALLBACK PHONE NUMBER SHOULD ALWAYS BE REVIEWED FOR ACCURACY BEFORE DISCONNECTING.

**23****FEATURE & REPORT SELECTIONS****5..... feature select**

Location 23 is used to enable certain features that can be accessed or are visible to the user from the keypad of the system. In addition, certain communicator reports are enabled in location 23. (For specific definitions, refer to the Glossary beginning on page 35)

Segment 1:

- 1 = On enables the Quick Arm feature.
- 2 = On enables the Re-exit feature.
- 3 = On enables the Automatic Bypass feature.
- 4 = On enables the Silent Keypad Panic feature (*overrides the audible panic selection*).
- 5 = On enables the Audible Keypad Panic feature.
- 6 = On enables the Keypad Aux 1 feature (FIRE).
- 7 = On enables the Keypad Aux 2 feature (MEDICAL).
- 8 = On enables the Keypad Multiple Code Attempt Tamper feature.

Segment 2:

- 1 = On enables the LED Extinguish feature.
- 2 = On enables the Require Code for Bypassing feature.
- 3 = On enables the Zone Bypassed Sounder Alert feature.
- 4 = On enables the AC Power/Low Battery Sounder Alert feature.
- 5 = On enables Bypass toggle.
- 6 = On enables Silent Auto Arm.
- 7 = On enables the Automatic Instant feature.
- 8 = On enables Instant mode toggle. (Applies to NX-1208E / NX-1248E keypads)

Segment 3:

- 1 = On enables Opening and Closing reports.
- 2 = On enables Zone Bypass reporting.
- 3 = On enables Zone Restore reporting.
- 4 = On enables Zone Trouble reporting.
- 5 = On enables Zone Tamper reporting.
- 6 = On enables the Cancel reporting.
- 7 = On enables the Recent Closing report.
- 8 = On enables the Exit Error report.

Segment 4:

- 1 = On enables Late to Close / Early to Open.
- 2 = On enables Auto Arm in Stay Mode.
- 3 = On disables the door delays in Night mode. (Applies to NX-1208E / NX-1248E keypads)
- 4 - 8 = Reserved.

Segment 5: Reserved



Location 24 is used to program the Entry/Exit times. There are 2 separate Entry/Exit times.

- Segment 1, Entry time 1:** This is the entry time that will be used when a delay 1 zone type initiates an entry delay. Valid entries are 30-255 seconds.
- Segment 2, Exit time 1:** This is the exit time that will be used for all zones designated as delay 1. Valid entries are 45-255 seconds.
- Segment 3, Entry time 2:** This is the entry time that will be used when a delay 2 zone type initiates an entry delay. Valid entries are 30-255 seconds.
- Segment 4, Exit time 2:** This is the exit time that will be used for all zones designated as delay 2. Valid entries are 45-255 seconds.
- Segments 5 & 6** Reserved.

XIII. DEFAULT ZONE TYPES (Configurations)

Zones can be programmed to be one of thirty different zone types (configurations). Zone types 17 - 20 can be used for wireless or hardwired zones using European double EOL configuration. The default zone types are listed below. These zone types can be customized by programming locations 110-169.

DATA	DESCRIPTION OF DEFAULT ZONE TYPES
1	DAY ZONE - Instant when system is armed trouble zone when system is disarmed.
2	24-HOUR AUDIBLE - Creates an instant yelping siren alarm regardless of the armed state of the control panel.
3	ENTRY/EXIT DELAY 1 - A trip will start entry delay 1. The lack of a trip during exit delay will enable the Automatic Bypass or Instant mode if so programmed.
4	FOLLOWER WITH AUTO- BYPASS DISABLED - This zone will be instant when the system is armed and no entry or exit delays are being timed. It is delayed during entry and exit delay 1 times. This zone will not automatically bypass even if enabled in Segment 1 of Location 23.
5	INTERIOR FOLLOWER WITH AUTO- BYPASS ENABLED - This zone will be instant when the system is armed and no entry or exit delay is being timed. It is delayed during entry and exit delay 1 times. This zone will automatically bypass if enabled in Segment 1 of Location 23.
6	INSTANT - This zone creates an instant alarm whenever it is tripped and the Armed LED is on.
7	24-HOUR SILENT - Creates an instant silent alarm regardless of the armed state of the control panel. It will not display on the keypad.
8	FIRE - This zone will light the Fire LED and sound the temporal siren each time the zone is shorted. It will also rapidly flash the Fire LED indicating a trouble if the zone is open.
9	ENTRY/EXIT DELAY 2 - A trip will start entry delay 2. The lack of a trip during exit delay will enable the Automatic Bypass or Instant mode if so programmed.
10	24-HOUR SILENT SUPERVISED - Creates an instant silent alarm regardless of the armed state of the control panel. It will display on the keypad.
11	RESERVED
12	INTERIOR FOLLOWER WITH "CROSS ZONE" ENABLED - This zone will be instant when the system is armed and no entry or exit delay is being timed. It is delayed during entry and exit delay times. If a "Cross Zone" is not being timed it will start a "Cross Zone" timer. If a "Cross Zone" is being timed it will create an instant alarm. This zone will automatically bypass when enabled in Segment 1 of Location 23.
13	INSTANT ENTRY GUARD - This zone creates an instant alarm whenever it is tripped and the Stay LED is off. It will start an entry delay time 2 if it is tripped and the system is armed and the Stay LED is on.
14	ENTRY/EXIT DELAY 1 WITH GROUP BYPASS ENABLED - A trip will start entry delay 1. This zone will bypass when the "Group Bypass" command is entered at the keypad. The lack of a trip during exit delay will enable the Automatic Bypass or Instant mode if so programmed.
15	INTERIOR FOLLOWER WITH GROUP BYPASS ENABLED - This zone will be instant when the system is armed and no entry or exit delays are being timed. It is delayed during entry/exit delay times. This zone will bypass when the "Group Bypass" command is entered at the keypad. This zone will automatically bypass if enabled in Segment 1 of Location 23.
16	INSTANT WITH GROUP BYPASS ENABLED - This zone creates an instant alarm whenever it is tripped and the Armed LED is on. This zone will bypass when the "Group Bypass" command is entered at the keypad.
17	ENTRY/EXIT DELAY 1 WITH TAMPER ENABLED - A trip will start entry delay 1. The lack of a trip during exit delay will enable the Automatic Bypass or Instant mode if so programmed. <i>This zone type can be used to enable tamper on a wireless transmitter.</i>
18	INTERIOR FOLLOWER WITH TAMPER AND AUTO-BYPASS ENABLED - This zone will be instant when the system is armed and no entry or exit delay is being timed. It is delayed during entry and exit delay times. This zone will automatically bypass if enabled in Segment 1 of Location 23. <i>This zone type can be used to enable tamper on a wireless transmitter.</i>
19	INSTANT WITH TAMPER ENABLED - This zone creates an instant alarm whenever it is tripped and the Armed LED is on. <i>This zone type can be used to enable tamper on a wireless transmitter.</i>

DATA	DESCRIPTION OF DEFAULT ZONE TYPES
20	ENTRY/EXIT DELAY 2 WITH TAMPER ENABLED -A trip will start entry delay 2. The lack of a trip during exit delay will enable the Automatic Bypass or Instant mode if so programmed. <i>This zone type can be used to enable tamper on a wireless transmitter.</i>
21	GAS DETECTION - Creates an instant alarm regardless of the armed state of the control panel. It will display on the keypad and activate the keypad sounder.
22	LOW TEMP DETECTION - Creates an instant silent alarm regardless of the armed state of the control panel. It will display on the keypad and activate the keypad sounder.
23	HIGH TEMP DETECTION - Creates an instant silent alarm regardless of the armed state of the control panel. It will display on the keypad and activate the keypad sounder.
24	MANUAL FIRE - This zone will illuminate the Fire LED and sound the temporal siren each time the zone is shorted. It will also rapidly flash the Fire LED indicating a trouble if the zone is open.
25	CHIME ONLY - Creates no alarm regardless of the armed state of the control panel. It will chime anytime it is faulted and will display on the keypad. Local only.
26	INTERIOR FOLLOWER DELAY 2 - This zone will be instant when the system is armed and no entry or exit delay is being timed. It is delayed during entry and exit delay 2 times. This zone will automatically bypass if enabled in Segment 1 of Location 23.
27	INTERIOR FOLLOWER FORCE ARMABLE - This zone will be instant when the system is armed and no entry or exit delay is being timed. It is delayed during entry and exit delay 1 times. This zone will automatically bypass if enabled in Segment 1 of Location 23.
28	ENTRY/EXIT FORCE ARMABLE DELAY 2 - A trip will start entry delay 2. The lack of a trip during exit delay will enable the Automatic Bypass or Instant mode if so programmed.
29	INTERIOR FOLLOWER WITH ACTIVITY SUPERVISION ENABLED - This zone will be instant when the system is armed and no entry or exit delay is being timed. It is delayed during entry and exit delay times. It will send a report if the zone activity time is reached without a change of state. Refer to Location 40 / Segment 11. This zone will automatically bypass if enabled in Segment 1 of Location 23.
30	ENTRY/EXIT WITH ACTIVITY SUPERVISION ENABLED - A trip will start entry delay 1. It will send a report if the zone activity time is reached without a change of state. Refer to Location 40 / Segment 11. The lack of a trip during exit delay will enable the Automatic Bypass or Instant mode if so programmed.

 **25 ZONES 1-8 ZONE TYPE** 8..... numerical
 Location 25 contains the Zone Type for zones 1-8. Segment 1 is for zone 1, and Segment 8 is for zone 8. Default Zone Types are found in the table on page 16. To customize a Zone Type, see page 23.

26 - 36 RESERVED

 **37 SIREN AND SYSTEM SUPERVISION** 7..... feature select
 Location 37 is used to enable various system feature and reporting options. (For specific definitions, refer to the Glossary beginning on page 35)

Segment 1:

- 1 = On if siren sounds for "Telephone Line Cut" when armed.
- 2 = On if siren sounds for "Telephone Line Cut" when disarmed.
- 3 = On if siren blast at arming.
- 4 = On if siren blast at exit expiration.
- 5 = On if siren blast at closing kissoff.
- 6 = On if siren sounds during a "Cross Zone" verification time.
- 7 = On if siren sounds for a Zone or Box Tamper.
- 8 = On if siren blasts 1 time for keyswitch or wireless arming; 2 times for disarming. (**Note:** Must be disabled for SIA CP-01 installations.)

Segment 2:

- 1 = On if siren driver should be a voltage output. Off if on board siren driver enabled.
- 2 = On if siren sounds for expander trouble (required for UL installations).
- 3 = On for Immediate Restore by zone. Off for zones to restore only when siren is off.
- 4 = On if Dynamic Battery Test performed at arming. Off if performed at disarming. (See location 40)
- 5 = On if Battery Missing Test is performed every 12 seconds.
- 6 = On if Manual Bell Test performed during [*]-[4]-[4] test function.
- 7 = On if Manual Communicator Test performed during [*]-[4]-[4] test function.
- 8 = On if Box Tamper terminals on the control panel are enabled.

Segment 3:

- 1 = On if Box Tamper report enabled.
- 2 = On if AC Fail reporting enabled.
- 3 = On if Low Battery reporting enabled.
- 4 = On if Aux. Power Overcurrent report enabled.
- 5 = On if Siren Supervision report enabled.
- 6 = On if Telephone Line Cut report enabled.
- 7 = Reserved.
- 8 = On if Expander Trouble reporting enabled.

Segment 4:

- 1 = On if Fail To Communicate report enabled.
- 2 = On if Log Full report enabled.
- 3 = On if Autotest report enabled.
- 4 = On if Start/End programming report enabled.
- 5 = On if End Download report enabled.
- 6 = On if Sensor Low Battery report enabled.
- 7 = On if Sensor Missing report enabled.
- 8 = On if First to Open / Last to Close.

Segment 5:

- 1 = On enable Lost Clock service light.
- 2 = On enables Zone Doubling (requires NX-200 Zone Doubling Kit).
- 3 = On disables On-Board 4 zones.
- 4 = On will allow two trips on same cross-zone to activate an alarm.
- 5 = On will **not** allow zones that are force armed to report bypass.
- 6 = Reserved.
- 7 = Use internal crystal for clock.
- 8 = Disable Temporal Siren on Fire. **NOTE:** Do NOT disable for UL listed systems.

Segment 6:

- 1 = Reserved.
- 2 = Reserved.
- 3 = Enable for Zone Activity in Hours (not Days)
- 4 = Enable Daylight Savings Time (DST)
- 5 = Reserved
- 6 = On to disable Clean Me report (At default, bit is OFF = enabled)
- 7 = Disable Start/End Test report (At default, bit is OFF = enabled)
- 8 = Reserved.

Segment 7: Reserved

	38	SWINGER SHUTDOWN COUNT	1 numerical
Location 38 contains the number of trips during an arming cycle that the NX-4V2 will allow before bypassing a zone. The count determination is described in the Glossary. Factory default is 1.			

	39	KEYPAD SOUNDER CONTROL	1 feature select
--	-----------	-------------------------------	-------------------------------

Segment 1:

- 1 = On if keypad sounds for "Telephone Line Cut" when the system is armed .
- 2 = On if keypad sounds for "Telephone Line Cut" when disarmed.
- 3 = On if keypad sounds upon AC Power Failure.
- 4 = On if keypad sounds when a Low Battery is detected.
- 5 = On if keypad sounds during Cross Zone trip time.
- 6 = On if keypad sounds for zone and box tampers.
- 7 = Reserved.
- 8 = On if keypad sounds for expander trouble (required for UL installations).

**40****SYSTEM TIMERS****14..... numerical**

Location 40 contains the duration of various system timing functions. Example: If you desire the duration of the Dynamic Battery Test to be 30 minutes, you should program [3]-[0]-[*] in segment 1 of this location. The [3]-[0] is the number of minutes, and the [*] stores the data and moves to the next segment of this location.

NOTES FOR UL INSTALLATIONS

The "Listen-In" feature cannot be enabled for UL Listed systems.
 The "Dynamic Battery Test" feature cannot exceed four (4) hours.
 The dial delay shall be set to -0-. Must be disabled by zone type in Loc 110-169.
The combined Dial Delay and Entry Delay (loc 24) must not exceed 1 minute for SIA CP-01 requirements.

- Segment 1** - Dynamic Battery Test duration in minutes 0-255 minutes (0 = no test)
- Segment 2** - AC Fail report delay in minutes 0-255 minutes. (0 = no delay)
- Segment 3** - Power Up Delay in seconds 0-60 seconds (0 = no power up delay)
- Segment 4** - Siren Time in minutes 1-254 minutes.
- Segment 5** - Telephone Line Cut delay in seconds 0-255 seconds (0 = no TLM)
- Segment 6** - Cross Zone time in minutes 0-255 (0 = no cross zoning)
- Segment 7** - Chime time in 50 mS (1/20th second) increments from 0-12 seconds (0 = follows zone 255 latched)
- Segment 8** - Dial delay in seconds 15-255 seconds (0 = no abort delay)
- Segment 9** - Fire Alarm Verification time in seconds 120-255 seconds (0 = no fire alarm verification)
NOTE: The fire alarm verification feature is not approved for residential use in California
- Segment 10** - Listen-In time in seconds 0-255 (0 = no Listen-In time)
- Segment 11** - Zone Activity Monitor feature timed in days 0 – 255 (0 = disabled)
- Segments 12-14** Reserved.

41**SPECIAL FEATURES****1..... feature select****Segment 1:**

- 1 = On enables the 6-digit code option. If 6-digit option is enabled, all arm/disarm codes and the "Go To Program Code" are 6 digits. If this option is enabled, the default user 1 code is [1]-[2]-[3]-[4]-[5]-[6].
NOTE: IF YOU ENABLE THIS OPTION, VERIFY THAT THE "GO TO PROGRAM CODE" IS A SIX-DIGIT CODE BEFORE EXITING PROGRAMMING.
- 2 = On requires code entry for [*]-[9]-[8] (perform call back download) and [*]-[9]-[9] (answer incoming call for download) functions.
- 3 = Enable Auto Cancel / Abort (Refer to Glossary beginning on page 35)
- 4 = Enable Walk-Test Mode (Refer to Glossary beginning on page 35)
- 5 = On enables Auto Force-Arming with keyfob or keyswitch.

**42****GO TO PROGRAM CODE****6..... numerical**

Location 42 contains the "Go To Program Code". This location contains either a 4 or 6-digit code. If the 6-digit code option is enabled in Location 41, THIS CODE MUST CONTAIN SIX (6) DIGITS. If this option is not enabled in location 41, the last 2 segments (digits) will be ignored. With the NX-4V2 disarmed, the "Go To Program Code" can be used to enter the Program Mode.

43**GO TO PROGRAM CODE & AUTHORIZATION****2..... feature select**

The "Go To Program Code" can be used as a standard arm/disarm code. When using the code to arm or disarm, the user ID is 255. (This code may not be changed in the Run Mode.)

Segment 1:

- 1 = Reserved.
- 2 = On enables "Go To Program Code" as an arm only code.
- 3 = On enables "Go To Program Code" as an arm only after closing.
- 4 = On enables "Go To Program Code" as a master arm/disarm code (can change user codes)
- 5 = On enables "Go To Program Code" as an arm/disarm code.
- 6 = On enables "Go To Program Code" to bypass zones.
- 7 = On enables "Go To Program Code" opening and closing reports.
- 8 = Reserved.

Segment 2: Reserved**44****DURESS CODE****6..... numerical**

Location 44 contains the "Duress" code. This Location contains either 4 or 6 digits. If the 6-digit code option is enabled in Location 41, THIS CODE MUST CONTAIN SIX (6) DIGITS. If the 6-digit option is not enabled in location 41, the last 2 digits will be ignored.

45**RESERVED**

46 AUXILIARY OUTPUT 1 - 2 SPECIAL TIMING 2 feature select

Location 46 contains special timing feature activation for the four auxiliary outputs. Segment 1 corresponds to output 1; Segment 2 corresponds to output 2.

Segments 1 - 2:

- 1 = On if output should be timed in minutes; Off if timed in seconds.
- 2 = On if output should latch; Off if output should be timed.
- 3 = On if output should stop timing upon code entry; Off if the output should continue to time upon code entry.
- 4 = On if output should only activate between the closing and opening time in loc. 52 and 53.
- 5 = On if output should only activate between the opening and closing time in loc. 52 and 53.
- 6 = On if output should be inverted (0 volts going to 12 volts when activated).
- 7 = Reserved.
- 8 = Reserved.

47 AUXILIARY OUTPUT 1, EVENT & TIME 2 numerical

Segment 1: Use Table XIII-1 to select the event that will activate Auxiliary Output 1.
Segment 2: Program the timing from 0-255 (minutes or seconds, depending on data programmed in Segment 1, Location 46). Programming a "0" makes the output follow the event.

48 AUXILIARY OUTPUT 2, EVENT & TIME 2 numerical

Segment 1: Use Table XIII-1 to select the event that will activate Auxiliary Output 2.
Segment 2: Program the timing from 0-255 (minutes or seconds, depending on data programmed in Segment 2, Location 46). Programming a "0" makes the output follow the event.

49 - 50 RESERVED

Table XIII-1 AUXILIARY OUTPUT EVENT SELECTION

DATA	EVENT	DATA	EVENT	DATA	EVENT
0 ✓	Burglary Alarm	19	Exit	38	Download In Process
1 ✓	Fire Alarm	20	Entry or Exit	39	Smoke Power
2 ✓	24 Hour Alarm	21	Armed State	40	Short Circuit (Over-current)
3 ✓	Trouble Alarm	22	Disarmed State	41	Box Tamper
4 ✓	Tamper Alarm	23	Ready	42	Siren Tamper
5	Yelping Siren (Burglary)	24	Not Ready	43	Any Open
6	Temporal Siren (Fire)	25	Fire	44	Any Short
7	Any Siren	26	Fire Trouble	45	Any Fault (Open/ Short on Non-Fire Zone)
8	Any Bypass	27	Chime	46 ✓	Any Alarm
9	AC Fail	28 ✓	Expander Trouble	47	Beeping Keypad
10	Low Battery	29	Dynamic Battery Test Time	48 ✓	Code Entry (See note below)
11 ✓	Duress	30	Open Period	49 ❖ ✓	Key FOB Function 1
12 ✓	Aux 1 Keypad Zone	31	Closed Period	50 ❖ ✓	Key FOB Function 2
13 ✓	Aux 2 Keypad Zone	32	Listen-In	51	Always ON
14 ✓	Panic Keypad Zone	33	Line Seizure	52	Alarm Flash
15	Keypad Tamper	34	Ground Start	53	Armed Away
16 ✓	Autotest	35	Fail To Communicate	54	Armed Stay
17	Alarm Memory	36	Telephone Line Fault	55	Aux Comm Fail
18	Entry	37	Program Mode	56	(CP-01) Progress Annunciation

❖ Events 49 & 50 require one or more of the following to operate: NX-408E, NX-416E, NX-448E wireless receivers, or NX-1700E card reader
 ✓ If set to follow condition, these events will be 1 second.

Note: When Event 48 is programmed, it is possible to program a user code's authorization to select which output(s) a particular code will activate. When LED 8 is on for an authorization, then LEDs 1 - 2 correspond to that code activating outputs 1 - 2 respectively. **(See programming the LED keypads on page 7.)**

51 AUTOTEST CONTROL 4 numerical

Segment 1: Program a "1" if the interval is to be in hours; Program a "0" if in days. Add a "2" to suppress the daily test or a "3" to suppress the hourly test if any report has been sent.
Segment 2: Program the Autotest interval from 1-255 hours/days.
Segment 3: Program the Autotest report hour in 24-hour format (if the interval is in hours, this segment is ignored).
Segment 4: Program the Autotest report time, number of minutes after the hour.

52**OPENING TIME****2..... numerical**

Location 52 contains the time in 24 hour format the NX-4V2 enables codes designated as arm only after closing. This time is only valid on those days programmed in location 54. **Note:** Opening time must be earlier than closing time for Auto Arm, Aux. Outputs, or Code Authorization to function properly.

Segment 1: Program the hour of the opening time.

Segment 2: Program the minutes after the hour of the opening time.

53**CLOSING TIME/AUTOMATIC ARMING TIME****2..... numerical**

Location 53 contains the time in 24 hour format the NX-4V2 disables the disarm capability for codes designated as arm only after closing. This is also the time the Automatic Arming sequence will begin (if enabled in location 55)..

Segment 1: Program the hour of the closing / auto arm time.

Segment 2: Program the minutes after the hour of the closing / auto arm time.

54**DAYS OF WEEK SYSTEM IS OPEN****1..... feature select**

Location 54 selects which days of the week the system is open. On these days, "arm only after close window" codes will be able to arm and disarm during open window. **NOTE: If system is not programmed to be opened and is programmed to Auto-Arm (Location 55), the NX-4V2 will try to arm every 45 minutes for the duration of the closed period unless Auto Retry is disabled in location 55.** On days not selected here, "arm only after close window" codes will not disarm. (See locations 52 and 53 for the opening and closing times for the open days.)

Segment 1:

- 1 = Open on Sunday.
- 2 = Open on Monday.
- 3 = Open on Tuesday.
- 4 = Open on Wednesday.
- 5 = Open on Thursday.
- 6 = Open on Friday.
- 7 = Open on Saturday.
- 8 = Reserved.

55**DAYS OF WEEK SYSTEM WILL AUTO ARM****1..... feature select**

Location 55 selects which days the system will auto arm. If a zone is faulted when the panel tries to auto arm, the zone will be bypassed.

Segment 1:

- 1 = Auto Arming on Sunday.
- 2 = Auto Arming on Monday.
- 3 = Auto Arming on Tuesday.
- 4 = Auto Arming on Wednesday.
- 5 = Auto Arming on Thursday.
- 6 = Auto Arming on Friday.
- 7 = Auto Arming on Saturday.
- 8 = Disable 45 minute retry timer.

LOCATIONS 56- 83 ARE ONLY USED WHEN REPORTING EVENTS TO A PAGER OR USING A SLOW FORMAT SUCH AS 4+2. When using Contact ID or SIA, there is no need to program these locations.

The digit programmed in each of the following locations will be sent as the upper HEX digit in place of the alarm event code. The zone ID or user ID will always be reported as the lower HEX digit (1-F). For example, if the zone ID or user ID is 3, the 4+2 lower digit will be "3". See Appendix 4 on page 41. If the segment is left as "0" and the feature is enabled in Location 23, the NX-4V2 will report "A".

56	RESTORE COMMUNICATOR CODE	1	numerical
Location 56 contains the event code for any zone "Restore" for a 4+2 format. (Box on pg 22.)			
57	BYPASS COMMUNICATOR CODE	1	numerical
Location 57 contains the event code for a zone "Bypass" for a 4+2 format. (Box on pg 22.)			
58	TAMPER COMMUNICATOR CODE	1	numerical
Location 58 contains the event code for a zone "Tamper" for a 4+2 format. (Box on pg 22.)			
59	TROUBLE COMMUNICATOR CODE	1	numerical
Location 59 contains the event code for a zone "Trouble" for a 4+2 format. (Box on pg 22.)			
60	SENSOR LOW BATTERY COMMUNICATOR CODE	1	numerical
Location 60 contains the event code for a zone "Sensor Low Battery" for a 4+2 format. (Box on pg 22.)			
61	SENSOR MISSING COMMUNICATOR CODE	1	numerical
Location 61 contains the event code for a zone "Sensor Missing" for a 4+2 format. (Box on pg 22.)			
62	DURESS COMMUNICATOR CODE	2	numerical
Location 62 contains the digits that will be sent for a 4+2 format if the "Duress" code is enabled in location 44. (Box on pg 22.)			
63	KEYPAD AUXILIARY 1 COMMUNICATOR CODE	2	numerical
Location 63 contains the digits that will be sent for a 4+2 format if the keypad "Auxiliary 1" (Fire) is enabled in loc 23. (Box on pg 22.)			
64	KEYPAD AUXILIARY 2 COMMUNICATOR CODE	2	numerical
Location 64 contains the digits that will be sent for a 4+2 format if the keypad "Auxiliary 2" (Medical) is enabled in location 23. (Box on pg 22.)			
65	KEYPAD PANIC COMMUNICATOR CODE	2	numerical
Location 65 contains the digits that will be sent for a 4+2 format if the keypad "Panic" is enabled in location 23. (Box on pg 22.)			
66	KEYPAD MULTIPLE CODE ENTRY TAMPER COMM CODE	2	numerical
Location 66 contains the digits that will be sent for a 4+2 format if the keypad "Multiple Code Entry" (Tamper) is enabled in location 23. (Box on pg 22.)			
67	BOX TAMPER / RESTORE COMMUNICATOR CODE	4	numerical
Location 67 contains the digits that will be sent for a 4+2 format if the "Box Tamper" feature is enabled in location 37. Segments 1 & 2 contain the digits of the "Box Tamper". Segments 3 & 4 contain the digits of the "Box Tamper Restore". (Box on pg 22.)			
68	AC FAIL / RESTORE COMMUNICATOR CODE	4	numerical
Location 68 contains the digits for a 4+2 format that will be sent if "AC Fail Reporting" is enabled. Segments 1 & 2 contain the digits of the "AC Fail". Segments 3 & 4 contain the digits of the "AC Fail Restore". (Box on pg 22.)			
69	LOW BATTERY / RESTORE COMMUNICATOR CODE	4	numerical
Location 69 contains the digits for a 4+2 format that will be sent if "Low Battery Reporting" is enabled. Segments 1 & 2 contain the digits of the "Low Battery Reporting". Segments 3 & 4 contain the digits of the "Low Battery Restore". (Box on pg 22.)			
70	AUX POWER OVERCURRENT / RESTORE COMM CODE	4	numerical
Location 70 contains the digits for a 4+2 format that will be sent if "Aux Power Overcurrent Reporting" is enabled. Segments 1 & 2 contain the digits of the "Aux Power Overcurrent Reporting". Segments 3 & 4 contain the digits of the "Aux Power Overcurrent Restore". (Box on pg 22.)			
71	BELL TAMPER / RESTORE COMMUNICATOR CODE	4	numerical
Location 71 contains the digits for a 4+2 format that will be sent if siren supervision reporting is enabled. Segments 1 & 2 contain the digits of the "Bell Tamper Reporting". Segments 3 & 4 contain the digits of the "Bell Tamper Restore". (Box on pg 22.)			
72	TELEPHONE LINE CUT / RESTORE COMM CODE	4	numerical
Location 72 contains the digits for a 4+2 format that will be sent if "Telephone Line Cut Reporting" is enabled. Segments 1 & 2 contain the digits of the "Telephone Line Cut Reporting". Segments 3 & 4 contain the digits of the "Telephone Line Cut Restore". (Box on pg 22.)			
73	RESERVED		

74	EXPANDER TROUBLE / RESTORE COMM CODE	4..... numerical
Location 74 contains the digits for a 4+2 format that will be sent if "Expander Trouble Reporting" is enabled. Segments 1 & 2 contain the digits of the "Expander Trouble Reporting". Segments 3 & 4 contain the digits of the "Expander Trouble Restore". (Box on pg 22.)		
75	FAIL TO COMMUNICATE COMMUNICATOR CODE	2..... numerical
Location 75 contains the digits for a 4+2 format that will be sent if the "Fail To Communicate Reporting" is enabled. (Box on pg 22.)		
76	LOG FULL COMMUNICATOR CODE	2..... numerical
Location 76 contains the digits for a 4+2 format if the "Log Full Reporting" is enabled. (Box on pg 22.)		
77	OPENING COMMUNICATOR CODE	8..... numerical
Location 77 contains the digit of a 4+2 format if the "Opening Reporting" is enabled. (Box on pg 22.)		
78	CLOSING COMMUNICATOR CODE	8..... numerical
Location 78 contains the digit of a 4+2 format if the "Closing Reporting" is enabled. (Box on pg 22.)		
79	AUTOTEST COMMUNICATOR CODE	2..... numerical
Location 79 contains the digits for a 4+2 format that will be sent if the "Autotest" or "Manual Test" is enabled. (Box on pg 22.)		
80	RECENT CLOSING & EXIT ERROR COMM CODE	2..... numerical
Location 80 contains the digits for a 4+2 format that will be sent if "Recent Closing" and/or "Exit Error Reporting" is enabled. Segment 1 contains the digit for the "Recent Closing Reporting". Segment 2 contains the digit for the "Exit Error Reporting". (Box on pg 22.)		
81	START PROGRAM & END PROGRAM COMM CODES	4..... numerical
Location 81 contains the digits for a 4+2 format that will be sent if "Start / End Programming Reporting" is enabled. Segment 1 contains the digit for the "Start Program Reporting". Segment 2 contains the digit for the "Start Program Reporting". Segment 3 contains the digit for the "End Program Reporting". Segment 4 contains the digit for the "End Program Reporting". (Box on pg 22.)		
82	END DOWNLOAD COMMUNICATOR CODE	4..... numerical
Location 82 contains the digits for a 4+2 format that will be sent if "End Downloading Reporting" is enabled. Segments 1 and 2 are <i>Reserved</i> . Segment 3 contains the digit of the "End Download Reporting". Segment 4 contains the digit of the "End Download Reporting". (Box on pg 22.) Note: A start download report will be sent to the internal event log.		
83	CANCEL COMMUNICATOR CODE	1..... numerical
Location 83 contains the digit for a 4+2 format that will be sent if "Cancel Reporting" is enabled. Segment 1 contains the digit for the "Cancel Communicator Reporting". (Box on pg 22.)		
84-109	RESERVED	

LOCATIONS 110-169 ARE USED TO CHANGE THE ZONE TYPES (Configurations) AS LISTED IN THE TABLE ON PAGE 16. THESE LOCATIONS ARE CONSIDERED ADVANCED PROGRAMMING AND SHOULD ONLY BE CHANGED WITH A THOROUGH UNDERSTANDING OF THE OPERATION OF EACH BIT.

110	ZONE TYPE 1 ALARM EVENT CODE	1..... numerical
Location 110 contains the event code sent for a Contact ID or SIA report. The desired event code should be chosen from the list on page 16. The zone ID will be that zone that is in alarm. 4+2 Format Note: If 4+2 format is being used, the number programmed in this location will be sent as the upper hex digit. The digit in location 110 should be from 1 to 15 when using 4+2 formats. The zone ID or user ID will be the lower hex digit of the zone that is in alarm.		

111	ZONE TYPE 1 CHARACTERISTIC SELECT	5..... feature select
------------	--	------------------------------

Segment 1:

- 1 = Fire (turn on if this is a fire zone).
- 2 = 24 hour (turn on for non-fire 24 hour zones).
- 3 = Keyswitch zone. (normally open switch)
- 4 = Follower (turn on for burglary zones that are Instant during non-entry times).
- 5 = Delay 1 zone (follows timer 1 entry and exit times).
- 6 = Delay 2 zone (follows timer 2 entry and exit times).
- 7 = Interior (turn on if this zone should Automatically Bypass or Bypass for Stay Arming).
- 8 = Local only (turn on if this zone should not be reported).

Segment 2:

- 1 = On if Zone Type will beep the keypad for alarm.
- 2 = On if Zone Type will sound the yelping siren for alarm.
- 3 = On if Zone Type will sound the temporal siren for alarm.
- 4 = On if Zone Type will chime.

- 5 = On if Zone Type can be bypassed.
- 6 = On if Zone Type is included in the group shunt.
- 7 = On if Zone Type is force armable.
- 8 = On if Zone Type is entry guard.

Segment 3:

- 1- On enables Fast Loop Response. (50mS)- Off= 500mS
- 2- On enables Double End Of Line Tamper zone. (Mainly used for tamper on wireless zones)
- 3- On enables Trouble Reporting zone. (Day zone and Fire zones)
- 4- On if Zone Type is a Cross Zone.
- 5- On enables Dialer Delay zone. (See location 40, page 19)
- 6- On if Zone Type will swinger shutdown. (See location 38, page 18)
- 7- On enables Restore reporting.
- 8- On enables Listen-In. (See location 40, page 19)

Segment 4:

- 1 = On enables Zone Activity Monitor. (See location 40, page 19)
- 2 = On enables End of Line Resistor Defeat on Non-Fire/Non-Keypress zones.
- 3 = On enables zone to act as *request to exit* input / disables for alarm activation.
- 4 = On enables zone to act as access entry point (Refer to NX-1700E card reader instruction manual. Do not enable this segment unless configured with Access Control.)
- 5-8 = Reserved.

Segment 5: Reserved.

112 ZONE TYPE 2 ALARM EVENT CODE 1 numerical

Location 112 contains the event code sent for a Contact ID or SIA report. The desired event code should be chosen from the list on page 39. The zone ID will be that zone that is in alarm. If 4+2 format is being used, refer to Location 110 on page 23 for details.

113 ZONE TYPE 2 CHARACTERISTIC SELECT 5 feature select

Use "Zone Type Characteristic Selections" described in Location 111, page 23

114 ZONE TYPE 3 ALARM EVENT CODE 1 numerical

Location 114 contains the event code sent for a Contact ID or SIA report. The desired event code should be chosen from the list on page 39. The zone ID will be that zone that is in alarm. If 4+2 format is being used, refer to Location 110 on page 23 for details.

115 ZONE TYPE 3 CHARACTERISTIC SELECT 5 feature select

Use "Zone Type Characteristic Selections" described in Location 111, page 23

116 ZONE TYPE 4 ALARM EVENT CODE 1 numerical

Location 116 contains the event code sent for a Contact ID or SIA report. The desired event code should be chosen from the list on page 39. The zone ID will be that zone that is in alarm. If 4+2 format is being used, refer to Location 110 on page 23 for details.

117 ZONE TYPE 4 CHARACTERISTIC SELECT 5 feature select

Use "Zone Type Characteristic Selections" described in Location 111, page 23

118 ZONE TYPE 5 ALARM EVENT CODE 1 numerical

Location 118 contains the event code sent for a Contact ID or SIA report. The desired event code should be chosen from the list on page 39. The zone ID will be that zone that is in alarm. If 4+2 format is being used, refer to Location 110 on page 23 for details.

119 ZONE TYPE 5 CHARACTERISTIC SELECT 5 feature select

Use "Zone Type Characteristic Selections" described in Location 111, page 23

120 ZONE TYPE 6 ALARM EVENT CODE 1 numerical

Location 120 contains the event code sent for a Contact ID or SIA report. The desired event code should be chosen from the list on page 39. The zone ID will be that zone that is in alarm. If 4+2 format is being used, refer to Location 110 on page 23 for details.

121 ZONE TYPE 6 CHARACTERISTIC SELECT 5 feature select

Use "Zone Type Characteristic Selections" described in Location 111, page 23

122 ZONE TYPE 7 ALARM EVENT CODE 1 numerical

Location 122 contains the event code sent for a Contact ID or SIA report. The desired event code should be chosen from the list on page 39. The zone ID will be that zone that is in alarm. If 4+2 format is being used, refer to Location 110 on page 23 for details.

123 ZONE TYPE 7 CHARACTERISTIC SELECT 5 feature select

Use "Zone Type Characteristic Selections" described in Location 111, page 23

124	ZONE TYPE 8 ALARM EVENT CODE	1	numerical
Location 124 contains the event code sent for a Contact ID or SIA report. The desired event code should be chosen from the list on page 39. The zone ID will be that zone that is in alarm. If 4+2 format is being used, refer to Location 110 on page 23 for details.			
125	ZONE TYPE 8 CHARACTERISTIC SELECT	5	feature select
Use "Zone Type Characteristic Selections" described in Location 111, page 23			
126	ZONE TYPE 9 ALARM EVENT CODE	1	numerical
Location 126 contains the event code sent for a Contact ID or SIA report. The desired event code should be chosen from the list on page 39. The zone ID will be that zone that is in alarm. If 4+2 format is being used, refer to Location 110 on page 23 for details.			
127	ZONE TYPE 9 CHARACTERISTIC SELECT	5	feature select
Use "Zone Type Characteristic Selections" described in Location 111, page 23.			
128	ZONE TYPE 10 ALARM EVENT CODE	1	numerical
Location 128 contains the event code sent for a Contact ID or SIA report. The desired event code should be chosen from the list on page 39. The zone ID will be that zone that is in alarm. If 4+2 format is being used, refer to Location 110 on page 23 for details.			
129	ZONE TYPE 10 CHARACTERISTIC SELECT	5	feature select
Use "Zone Type Characteristic Selections" described in Location 111, page 23			
130	ZONE TYPE 11 ALARM EVENT CODE	1	numerical
Location 130 contains the event code sent for a Contact ID or SIA report. The desired event code should be chosen from the list on page 39. The zone ID will be that zone that is in alarm. If 4+2 format is being used, refer to Location 110 on page 23 for details.			
131	ZONE TYPE 11 CHARACTERISTIC SELECT	5	feature select
Use "Zone Type Characteristic Selections" described in Location 111, page 23			
132	ZONE TYPE 12 ALARM EVENT CODE	1	numerical
Location 132 contains the event code sent for a Contact ID or SIA report. The desired event code should be chosen from the list on page 39. The zone ID will be that zone that is in alarm. If 4+2 format is being used, refer to Location 110 on page 23 for details.			
133	ZONE TYPE 12 CHARACTERISTIC SELECT	5	feature select
Use "Zone Type Characteristic Selections" described in Location 111, page 23			
134	ZONE TYPE 13 ALARM EVENT CODE	1	numerical
Location 134 contains the event code sent for a Contact ID or SIA report. The desired event code should be chosen from the list on page 39. The zone ID will be that zone that is in alarm. If 4+2 format is being used, refer to Location 110 on page 23 for details.			
135	ZONE TYPE 13 CHARACTERISTIC SELECT	5	feature select
Use "Zone Type Characteristic Selections" described in Location 111, page 23			
136	ZONE TYPE 14 ALARM EVENT CODE	1	numerical
Location 136 contains the event code sent for a Contact ID or SIA report. The desired event code should be chosen from the list on page 39. The zone ID will be that zone that is in alarm. If 4+2 format is being used, refer to Location 110 on page 23 for details.			
137	ZONE TYPE 14 CHARACTERISTIC SELECT	5	feature select
Use "Zone Type Characteristic Selections" described in Location 111, page 23			
138	ZONE TYPE 15 ALARM EVENT CODE	1	numerical
Location 138 contains the event code sent for a Contact ID or SIA report. The desired event code should be chosen from the list on page 39. The zone ID will be that zone that is in alarm. If 4+2 format is being used, refer to Location 110 on page 23 for details.			
139	ZONE TYPE 15 CHARACTERISTIC SELECT	5	feature select
Use "Zone Type Characteristic Selections" described in Location 111, page 23			
140	ZONE TYPE 16 ALARM EVENT CODE	1	numerical
Location 140 contains the event code sent for a Contact ID or SIA report. The desired event code should be chosen from the list on page 39. The zone ID will be that zone that is in alarm. If 4+2 format is being used, refer to Location 110 on page 23 for details.			
141	ZONE TYPE 16 CHARACTERISTIC SELECT	5	feature select
Use "Zone Type Characteristic Selections" described in Location 111, page 23			
142	ZONE TYPE 17 ALARM EVENT CODE	1	numerical
Location 142 contains the event code sent for a Contact ID or SIA report. The desired event code should be chosen from the list on page 39. The zone ID will be that zone that is in alarm. If 4+2 format is being used, refer to Location 110 on page 23 for details.			
143	ZONE TYPE 17 CHARACTERISTIC SELECT	5	feature select
Use "Zone Type Characteristic Selections" described in Location 111, page 23			

144	ZONE TYPE 18 ALARM EVENT CODE	1	numerical
Location 144 contains the event code sent for a Contact ID or SIA report. The desired event code should be chosen from the list on page 39. The zone ID will be that zone that is in alarm. If 4+2 format is being used, refer to Location 110 on page 23 for details.			
145	ZONE TYPE 18 CHARACTERISTIC SELECT	5	feature select
Use "Zone Type Characteristic Selections" described in Location 111, page 23			
146	ZONE TYPE 19 ALARM EVENT CODE	1	numerical
Location 146 contains the event code sent for a Contact ID or SIA report. The desired event code should be chosen from the list on page 39. The zone ID will be that zone that is in alarm. If 4+2 format is being used, refer to Location 110 on page 23 for details.			
147	ZONE TYPE 19 CHARACTERISTIC SELECT	5	feature select
Use "Zone Type Characteristic Selections" described in Location 111, page 23			
148	ZONE TYPE 20 ALARM EVENT CODE	1	numerical
Location 148 contains the event code sent for a Contact ID or SIA report. The desired event code should be chosen from the list on page 39. The zone ID will be that zone that is in alarm. If 4+2 format is being used, refer to Location 110 on page 23 for details.			
149	ZONE TYPE 20 CHARACTERISTIC SELECT	5	feature select
Use "Zone Type Characteristic Selections" described in Location 111, page 23			
150	ZONE TYPE 21 ALARM EVENT CODE	1	numerical
Location 150 contains the event code sent for a Contact ID or SIA report. The desired event code should be chosen from the list on page 39. The zone ID will be that zone that is in alarm. If 4+2 format is being used, refer to Location 110 on page 23 for details.			
151	ZONE TYPE 21 CHARACTERISTIC SELECT	5	feature select
Use "Zone Type Characteristic Selections" described in Location 111, page 23			
152	ZONE TYPE 22 ALARM EVENT CODE	1	numerical
Location 152 contains the event code sent for a Contact ID or SIA report. The desired event code should be chosen from the list on page 39. The zone ID will be that zone that is in alarm. If 4+2 format is being used, refer to Location 110 on page 23 for details.			
153	ZONE TYPE 22 CHARACTERISTIC SELECT	5	feature select
Use "Zone Type Characteristic Selections" described in Location 111, page 23			
154	ZONE TYPE 23 ALARM EVENT CODE	1	numerical
Location 154 contains the event code sent for a Contact ID or SIA report. The desired event code should be chosen from the list on page 39. The zone ID will be that zone that is in alarm. If 4+2 format is being used, refer to Location 110 on page 23 for details.			
155	ZONE TYPE 23 CHARACTERISTIC SELECT	5	feature select
Use "Zone Type Characteristic Selections" described in Location 111, page 23			
156	ZONE TYPE 24 ALARM EVENT CODE	1	numerical
Location 156 contains the event code sent for a Contact ID or SIA report. The desired event code should be chosen from the list on page 39. The zone ID will be that zone that is in alarm. If 4+2 format is being used, refer to Location 110 on page 23 for details.			
157	ZONE TYPE 24 CHARACTERISTIC SELECT	5	feature select
Use "Zone Type Characteristic Selections" described in Location 111, page 23			
158	ZONE TYPE 25 ALARM EVENT CODE	1	numerical
Location 158 contains the event code sent for a Contact ID or SIA report. The desired event code should be chosen from the list on page 39. The zone ID will be that zone that is in alarm. If 4+2 format is being used, refer to Location 110 on page 23 for details.			
159	ZONE TYPE 25 CHARACTERISTIC SELECT	5	feature select
Use "Zone Type Characteristic Selections" described in Location 111, page 23			
160	ZONE TYPE 26 ALARM EVENT CODE	1	numerical
Location 160 contains the event code sent for a Contact ID or SIA report. The desired event code should be chosen from the list on page 39. The zone ID will be that zone that is in alarm. If 4+2 format is being used, refer to Location 110 on page 23 for details.			
161	ZONE TYPE 26 CHARACTERISTIC SELECT	5	feature select
Use "Zone Type Characteristic Selections" described in Location 111, page 23			
162	ZONE TYPE 27 ALARM EVENT CODE	1	numerical
Location 162 contains the event code sent for a Contact ID or SIA report. The desired event code should be chosen from the list on page 39. The zone ID will be that zone that is in alarm. If 4+2 format is being used, refer to Location 110 on page 23 for details.			







163	ZONE TYPE 27 CHARACTERISTIC SELECT	5..... feature select
Use "Zone Type Characteristic Selections" described in Location 111, page 23		
164	ZONE TYPE 28 ALARM EVENT CODE	1..... numerical
Location 164 contains the event code sent for a Contact ID or SIA report. The desired event code should be chosen from the list on page 39. The zone ID will be that zone that is in alarm. If 4+2 format is being used, refer to Location 110 on page 23 for details.		
165	ZONE TYPE 28 CHARACTERISTIC SELECT	5..... feature select
Use "Zone Type Characteristic Selections" described in Location 111, page 23		
166	ZONE TYPE 29 ALARM EVENT CODE	1..... numerical
Location 166 contains the event code sent for a Contact ID or SIA report. The desired event code should be chosen from the list on page 39. The zone ID will be that zone that is in alarm. If 4+2 format is being used, refer to Location 110 on page 23 for details.		
167	ZONE TYPE 29 CHARACTERISTIC SELECT	5..... feature select
Use "Zone Type Characteristic Selections" described in Location 111, page 23		
168	ZONE TYPE 30 ALARM EVENT CODE	1..... numerical
Location 168 contains the event code sent for a Contact ID or SIA report. The desired event code should be chosen from the list on page 39. The zone ID will be that zone that is in alarm. If 4+2 format is being used, refer to Location 110 on page 23 for details.		
169	ZONE TYPE 30 CHARACTERISTIC SELECT	5..... feature select
Use "Zone Type Characteristic Selections" described in Location 111, page 23		
170-205	RESERVED	
206	AUTO DISARM DAY SELECTION	1..... feature select
Location 206 selects which days the system will auto disarm. If a zone is faulted when the panel tries to auto disarm, the zone will be bypassed.		

Segment 1:

- 1 = Auto Disarming on Sunday.
- 2 = Auto Disarming on Monday.
- 3 = Auto Disarming on Tuesday.
- 4 = Auto Disarming on Wednesday.
- 5 = Auto Disarming on Thursday.
- 6 = Auto Disarming on Friday.
- 7 = Auto Disarming on Saturday.
- 8 = Reserved.

XIV. PROGRAMMING WORKSHEETS

(Factory defaults for segments are in **bold italics** text and "Quick Start" locations are identified with the  symbol.)

LOC	PG	DESCRIPTION	DEFAULT	PROGRAM DATA
 0	11	PHONE 1	<i>14-14-14-14-14-14-14-14-14-14-14-14-14-14-14-14-14-14-14-14</i>	-----
 1	11	PHONE 1, ACCOUNT CODE	<i>10 - 10 - 10 - 10 - 10 - 10</i>	-----
 2	11	PHONE 1, REPORTING FORMAT	<i>0</i>	-
 3	12	PHONE 1, DIAL ATTEMPTS BACKUP CONTROL	<i>8</i> <i>0</i>	- -
4	12	PHONE 1, SELECTING EVENTS TO REPORT TO PHONE 1		
		Segment 1 (Circle Numbers To Program)	Segment 2 (Circle Numbers To Program)	
		1 = <i>Alarms and Restores</i>	1 = <i>Tampers</i>	
		2 = <i>Open/Close</i>	2 = <i>Short Circuit</i>	
		3 = <i>Bypass</i>	3 = <i>Sensor Lost</i>	
		4 = <i>Zone Trouble</i>	4 = <i>Sensor Low Battery</i>	
		5 = <i>Power Trouble (AC Failure or Low Battery)</i>	5 = <i>Expander Trouble</i>	
		6 = <i>Siren & Telephone Fault</i>	6 = <i>Failure To Communicate</i>	
		7 = <i>Test Reports</i>	7 = <i>Zone Activity Monitor</i>	
		8 = <i>Program, Download, & Log Full</i>	8 = <i>Reserved</i>	
5	12	RESERVED		
 6	12	PHONE 2	<i>14-14-14-14-14-14-14-14-14-14-14-14-14-14-14-14-14-14-14-14</i>	-----
 7	12	PHONE 2, ACCOUNT CODE	<i>10 - 10 - 10 - 10 - 10 - 10</i>	-----
 8	12	PHONE 2, REPORTING FORMAT	<i>0</i>	-
9	13	PHONE 2, DIAL ATTEMPTS BACKUP CONTROL	<i>8</i> <i>0</i>	- -
10	13	PHONE 2, SELECTING EVENTS TO REPORT TO PHONE 2		
		Segment 1 (Circle Numbers To Program)	Segment 2 (Circle Numbers To Program)	
		1 = Alarms and Restores	1 = Tampers	
		2 = Open/Close	2 = Short Circuit	
		3 = Bypass	3 = Sensor Lost	
		4 = Zone Trouble	4 = Sensor Low Battery	
		5 = Power Trouble (AC Failure or Low Battery)	5 = Expander Trouble	
		6 = Siren & Telephone Fault	6 = Failure To Communicate	
		7 = Test Reports	7 = Zone Activity Monitor	
		8 = Program, Download, & Log Full	8 = Reserved	
11	13	RESERVED		
12	13	PHONE 3	<i>14-14-14-14-14-14-14-14-14-14-14-14-14-14-14-14-14-14-14-14</i>	-----
13	13	PHONE 3, ACCOUNT CODE	<i>10 - 10 - 10 - 10 - 10 - 10</i>	-----
14	13	PHONE 3, REPORTING FORMAT	<i>0</i>	-
15	13	PHONE 3, DIAL ATTEMPTS BACKUP CONTROL	<i>8</i> <i>0</i>	- -
16	14	PHONE 3, SELECTING EVENTS TO REPORT TO PHONE 3		
		Segment 1 (Circle Numbers To Program)	Segment 2 (Circle Numbers To Program)	
		1 = Alarms and Restores	1 = Tampers	
		2 = Open/Close	2 = Short Circuit	
		3 = Bypass	3 = Sensor Lost	
		4 = Zone Trouble	4 = Sensor Low Battery	
		5 = Power Trouble (AC Failure or Low Battery)	5 = Expander Trouble	
		6 = Siren & Telephone Fault	6 = Failure To Communicate	
		7 = Test Reports	7 = Zone Activity Monitor	
		8 = Program, Download, & Log Full	8 = Reserved	
17	14	RESERVED		
18	14	FORMAT OVERRIDE		
		Segment 1 (Circle Numbers To Program)	Segment 2 (Circle Numbers To Program)	
		1 = ON - 1800hz transmit; OFF - 1900hz	1 = ON - pager format (no handshake required)	
		2 = ON - 2300hz handshake; OFF - 1400hz.	2 = ON - 1400/2300 handshake	
		3 = ON - cksum parity; OFF - double round parity	3 = Reserved	
		4 = ON - 2 digit event code; OFF - 1 digit code	4 = Reserved	
		5 = Reserved.	5 = ON - Contact ID	
		6 = Reserved.	6 = ON - SIA	
		7 = ON - 20 p.p.s.; OFF - 10 or 40 p.p.s.	7 = ON - Contact ID or 4+3	
		8 = ON - 10 p.p.s.; OFF - 20 or 40 p.p.s.	8 = ON - DTMF	
		Segments 3 & 4 RESERVED		

LOC	PG	DESCRIPTION	DEFAULT	PROGRAM DATA
19	14	DOWNLOAD ACCESS CODE	8-4-8-0-0-0-0-0	-----
20	14	RINGS TO ANSWER DOWNLOAD	8	---
21	15	DOWNLOAD CONTROL Segment 1 (Circle Numbers To Program) 1 = Enables two call answering machine defeat 2 = Enables tone sniff answering machine defeat 3 = Requires callback before downloading 4 = Shutdown control panel 5 = Lock out local programming 6 = Lock out communicator programming 7 = Lock out download section 8 = Enables callback at autotest interval		
22	15	CALLBACK PHONE NUMBER	14-14-14-14-14-14-14-14-14-14-14-14-14-14-14-14	-----
23	15	FEATURE SELECTION Segment 1 (Circle Numbers To Program) 1 = Quick Arm 2 = Re-Exit 3 = Auto Bypass 4 = Silent Panic 5 = Audible Panic 6 = Auxiliary 1 7 = Auxiliary 2 8 = Multi Keypress Tamper Segment 2 (Circle Numbers To Program) 1 = LED extinguish enable 2 = Require user code for bypassing zones 3 = Bypass sounder alert 4 = AC power/low battery sounder alert 5 = Enables bypass toggle 6 = Enables silent auto arm 7 = Enables automatic instant 8 = Enables Instant mode toggle Segment 3 (Circle Numbers To Program) 1 = Open/Close 2 = Bypass 3 = Restore 4 = Trouble 5 = Tamper 6 = Cancel 7 = Recent Closing 8 = Exit Error Segment 4 (Circle Numbers To Program) 1 = Late to Close / Early to Open 2 = Auto Arm in Stay Mode 3 = Disables door delays in Night mode 4-8 = Reserved Segment 5 RESERVED		
24	16	ENTRY / EXIT TIMERS Segment 1 (Entry Time 1) Segment 2 (Exit Time 1) Segment 3 (Entry Time 2) Segment 4 (Exit Time 2) Segments 5 & 6	30 60 30 60 Reserved	
25	17	ZONES 1-8, ZONE TYPES	3-5-6-6-6-6-6-6	-----
29-36	17	RESERVED		
37	17	SIREN AND SYSTEM SUPERVISION Segment 1 (Circle Numbers To Program) 1 = Siren sounds for telephone line cut while armed. 2 = Siren sounds for telephone line cut while disarmed. 3 = Siren blast at arming. 4 = Siren blast at exit delay expiration. 5 = Siren blast at closing kissoff. 6 = Siren sounds during a cross-zone verification time. 7 = Siren sounds for a tamper. 8 = Siren blast one time for keyswitch arming, two times for disarming. (Note: Must be disabled for SIA CP-01 installations.) Segment 2 (Circle Numbers To Program) 1 = Convert siren driver to voltage out. 2 = Siren sounds for expander trouble (required for U.L.). 3 = Immediate Restore by zone. 4 = Dynamic battery test performed upon arming. 5 = Battery missing test performed every 12 seconds. 6 = Manual bell test performed during [*]-[4]-[4] test function. 7 = Manual communicator test performed during [*]-[4]-[4] test function. 8 = Box tamper enabled.		

LOC	PG	DESCRIPTION	DEFAULT	PROGRAM DATA
37	17	Segment 3 (Circle numbers to program) 1 = Box Tamper report enabled. 2 = AC Fail report enabled. 3 = Low Battery report enabled. 4 = Auxiliary power over current report enabled. 5 = Siren supervision report enabled. 6 = Telephone Line Cut report enabled. 7 = Reserved. 8 = Expander trouble report enabled.		
		Segment 4 (Circle Numbers To Program) 1 = Failure To Communicate report enabled. 2 = Log Full report enabled. 3 = Autotest report enabled. 4 = Start and End Programming report enabled. 5 = End Download report enabled. 6 = Sensor Low Battery report enabled. 7 = Sensor Missing report enabled. 8 = First to Open / Last to Close		
		Segment 5 (Circle numbers to program) 1 = Lost Clock service LED enable. 2 = Zone Doubling enable. 3 = Disable on-board 4 zones. 4 = Enables two trips on the same cross-zone to activate the alarm. 5 = Disables bypass reports for force armed zones 6 = Reserved. 7 = Clock uses internal crystal. 8 = Disable Temporal Siren on Fire (Do not disable on UL listed systems)		
		Segment 6 (Circle numbers to program) 1 = Reserved. 2 = Reserved. 3 = Enable Zone Activity in Hours (not Days) 4 = Enable Daylight Savings Time (DST) 5 = Reserved 6 = Disable Clean Me report 7 = Disable Start/End Test report 8 = Reserved		
		Segment 7 - RESERVED		
38	18	SWINGER SHUTDOWN COUNT	1	-
39	18	KEYPAD SOUNDER CONTROL		
		Segment 1 (Circle numbers to program) 1 = Keypad sounds for Telephone Line Cut when in the Armed state. 2 = Keypad sounds for Telephone Line Cut when in the Disarmed state. 3 = Keypad sounds upon AC Power Failure. 4 = Keypad sounds upon Low Battery Detection. 5 = Keypad sounds during Cross Zone Trip Time. 6 = Keypad sounds for Tamper Alarm. 7 = Reserved. 8 = Keypad sounds for expander trouble (required for UL).		
40	19	SYSTEM TIMERS		
		Segment 1 Dynamic Battery Test duration (0-255 minutes)	0	-
		Segment 2 AC Failure report delay (0-255 minutes)	5	-
		Segment 3 Power Up Delay (0-60 seconds)	60	-
		Segment 4 Siren Time (1-254 minutes)	8	-
		Segment 5 Telephone Line Cut delay (0-255 seconds)	0	-
		Segment 6 Cross Zone Time (0-255 minutes)	5	-
		Segment 7 Chime Time in 50 mS increments (0-255)	3	-
		Segment 8 Dialer delay (15-255 seconds)	30	-
		Segment 9 Fire Alarm Verification Time (120-255 sec.)	0	-
		Segment 10 Listen-In Time (0-255 seconds)	0	-
		Segment 11 Zone Monitor Timer (0-255 Days)	0	-
Segments 12 – 14 Reserved				
41	19	SPECIAL FEATURES		
		Segment 1 (Circle numbers to program) 1 = Enables 6-digit code option. All arm/disarm/Go To Program codes require six digits. 2 = Requires valid user code entry for [*]-[9]-[8] and [*]-[9]-[9] functions to work. 3 = Enable Auto Cancel / Abort. 4 = Enable Walk-Test Mode. 5 = Enables Auto Force-Arming with keyfob or keyswitch.		

LOC	PG	DESCRIPTION	DEFAULT	PROGRAM DATA
42	19	GO TO PROGRAM CODE	9-7-1-3-0-0	-----
43	19	GO TO PROGRAM CODE & AUTHORIZATION Segment 1 (Circle numbers to program) 1 = Reserved. 2 = Enables "Go To Program Code" as an arm only code. 3 = Enables "Go To Program Code" as an arm only after closing. 4 = Enables "Go To Program Code" as a master arm/disarm code (can change user codes) 5 = Enables "Go To Program Code" as an arm/disarm code. 6 = Enables "Go To Program Code" to bypass zones. 7 = Enables "Go To Program Code" opening and closing reports. 8 = Reserved. Segment 2 Reserved		
44	19	DURESS CODE	15-15-15-15-15-15	-----
45	19	RESERVED		
46	20	AUXILIARY OUTPUTS 1-2 SPECIAL TIMING Segments (Aux Out)		1 2
		1 = Aux output timed in minutes.		1 1
		2 = Aux output to latch.		2 2
		3 = Aux output to stop timing upon user code entry.		3 3
		4 = Aux output to activate only between closing & opening time.		4 4
		5 = Aux output to activate only between opening & closing time.		5 5
		6 = Invert auxiliary output (0 Volts going to 12V when activated).		6 6
		7 = Reserved		7 7
		8 = Reserved		8 8
47	20	AUXILIARY OUTPUT #1, EVENT & TIME Segment 1: Event number for output # 1 Segment 2: Timing for output # 1	0=Burglary alarm 10 seconds	
48	20	AUXILIARY OUTPUT #2, EVENT & TIME Segment 1: Event number for output # 2 Segment 2: Timing for output # 2	1=Fire alarm 10 seconds	
49 - 50		RESERVED		
51	20	AUTOTEST CONTROL Seg 1: Program a "1" if the interval is hours, a "0" if in days. Add a "2" to suppress the daily test or a "3" to suppress the hourly test. Seg 2: Program the autotest interval from 1-255 days or hours. Seg 3: Program the autotest report in 24-hour time format. Seg 4: Program the autotest report time, minutes after the hour.	1 24 2 0	
52	21	OPENING TIME Seg 1: Hour of the opening time. Seg 2: Minutes after the hour of opening time.	8 0	
53	21	CLOSING TIME / AUTO ARMING TIME Seg 1: Hour of closing time / auto arming time. Seg 2: Minutes after hour of closing / auto arming time.	20 0	
54	21	DAYS OF THE WEEK SYSTEM IS OPEN Segment 1:	Sunday Monday Tuesday Wednesday Thursday Friday Saturday Reserved	1 2 3 4 5 6 7 8
55	21	DAYS OF THE WEEK "AUTO ARMING" WILL OCCUR Segment 1:	Sunday Monday Tuesday Wednesday Thursday Friday Saturday Disable retry timer	1 2 3 4 5 6 7 8

COMMUNICATOR CODES FOR SLOW SPEED FORMATS ONLY

The digit programmed in each of the following locations will be sent as the upper HEX digit in place of the alarm event code. The zone ID or user ID will always be reported as the lower HEX digit (1-F). For example, if the zone ID or user ID is 6, the 4+2 lower digit will be "6". (Refer to Appendix 4 on page 41.)

- ✍ If Segments 2-8 are left as "0" (unprogrammed), they will follow the Segment 1 selection.
- If Segment 1 is left as "0" and the feature is enabled, the NX-4V2 will report "'A".

LOC	PG	DESCRIPTION	DEFAULT	PROGRAMMING DATA
56	22	RESTORE COMMUNICATOR CODE	0	--
57	22	BYPASS COMMUNICATOR CODE	0	--
58	22	TAMPER COMMUNICATOR CODE	0	--
59	22	TROUBLE COMMUNICATOR CODE	0	--
60	22	SENSOR LOW BATTERY COMMUNICATOR CODE	0	--
61	22	SENSOR MISSING COMMUNICATOR CODE	0	--
62	22	DURESS	0-0	--
63	22	AUXILIARY 1	0-0	--
64	22	AUXILIARY 2	0-0	--
65	22	KEYPAD PANIC	0-0	--
66	22	KEYPAD MULTIPLE CODE ENTRY TAMPER	0-0	--
67	22	BOX TAMPER / BOX TAMPER RESTORE	0-0-0-0	----
68	22	AC FAIL / AC RESTORE	0-0-0-0	----
69	22	LOW BATTERY / LOW BATTERY RESTORE	0-0-0-0	----
70	22	POWER SHORT / POWER SHORT RESTORE	0-0-0-0	----
71	22	BELL TAMPER / BELL TAMPER RESTORE	0-0-0-0	----
72	22	TELEPHONE LINE CUT / LINE CUT RESTORE	0-0-0-0	----
73	22	Reserved	0-0-0-0	----
74	23	EXPANDER TROUBLE / EXP TROUBLE RESTORE	0-0-0-0	----
75	23	FAILURE TO COMMUNICATE	0-0	--
76	23	LOG FULL COMMUNICATOR CODE	0-0	--
77	23	OPENING CODE COMMUNICATOR CODE	0	--
78	23	CLOSING COMMUNICATOR CODE	0	--
79	23	AUTOTEST COMMUNICATOR CODE	0-0	--
80	23	RECENT CLOSING AND EXIT ERROR	0-0	--
81	23	START PROGRAMMING / END PROGRAMMING	0-0-0-0	----
82	23	END DOWNLOAD	0-0-0-0	XX--
83	23	CANCEL COMMUNICATOR CODE	0	--
84-109	23	RESERVED		
110	23	ZONE TYPE 1 ALARM EVENT CODE	8	--
111	23	ZONE TYPE 1 CHARACTERISTIC SELECT		
		Segment 1		
		1 = Fire (enable for fire zone)	5 = Delay 1 zone (enable to follow Timer 1 Entry/Exit times)	
		2 = 24-Hour (enable for non-fire 24 hour)	6 = Delay 2 zone (enable to follow Timer 2 Entry / Exit times)	
		3 = Keyswitch zone	7 = Interior (Enable for auto bypass or stay arming)	
		4 = Follower (enable for burg zones that are instant during non-entry times)	8 = Local Only (enable if zone is not to be reported)	
		Segment 2		
		1 = Keypad audible on alarm.	5 = Bypassable.	
		2 = Yelping siren on alarm.	6 = Group Shunt.	
		3 = Temporal siren on alarm.	7 = Force armable.	
		4 = Chime.	8 = Entry Guard.	
		Segment 3		
		1 = Fast Loop Response.	5 = Dialer Delay zone.	
		2 = Double End of Line Tamper zone.	6 = Swinger zone.	
		3 = Trouble zone (Day zone).	7 = Restore reporting.	
		4 = Cross Zone.	8 = Listen-In.	
		Segment 4		
		1 = Zone Activity Monitor.		
		2 = End of Line Resistor Defeat.		
		3-8 = Reserved.		
		Segment 5 RESERVED		

LOCATIONS 112 – 169

EVEN NUMBERED Contains the event code sent for Contact ID or SIA and chosen from the list on pg 16. **4+2 Format Note:** If 4+2 format is being used, the number programmed in this location will be sent as the upper hex digit. The digit should be from 1 to 15 when using 4+2 formats. The zone ID or user ID will be the lower hex digit of the zone that is in alarm.

ODD NUMBERED The defaults listed below represent the five segments of each of those locations. Use the data from location 111 (table on pg 32 and instructions on pg 23)

LOC	DESCRIPTION	DEFAULT	PROGRAMMING DATA
112	ZONE TYPE 2 ALARM EVENT CODE	2	___
113	ZONE TYPE 2 CHARACTERISTIC SELECT	2-125-78-0-0	___
114	ZONE TYPE 3 ALARM EVENT CODE	7	___
115	ZONE TYPE 3 CHARACTERISTIC SELECT	5-1245-5678-0-0	___
116	ZONE TYPE 4 ALARM EVENT CODE	5	___
117	ZONE TYPE 4 CHARACTERISTIC SELECT	45-125-5678-0-0	___
118	ZONE TYPE 5 ALARM EVENT CODE	5	___
119	ZONE TYPE 5 CHARACTERISTIC SELECT	457-125-5678-0-0	___
120	ZONE TYPE 6 ALARM EVENT CODE	4	___
121	ZONE TYPE 6 CHARACTERISTIC SELECT	0-1245-5678-0-0	___
122	ZONE TYPE 7 ALARM EVENT CODE	0	___
123	ZONE TYPE 7 CHARACTERISTIC SELECT	2-0-78-0-0	___
124	ZONE TYPE 8 ALARM EVENT CODE	1	___
125	ZONE TYPE 8 CHARACTERISTIC SELECT	1-13-378-0-0	___
126	ZONE TYPE 9 ALARM EVENT CODE	7	___
127	ZONE TYPE 9 CHARACTERISTIC SELECT	6-1245-5678-0-0	___
128	ZONE TYPE 10 ALARM EVENT CODE	2	___
129	ZONE TYPE 10 CHARACTERISTIC SELECT	24-5-78-0-0	___
130	ZONE TYPE 11 ALARM EVENT CODE	3	___
131	ZONE TYPE 11 CHARACTERISTIC SELECT	3-0-0-0-0	___
132	ZONE TYPE 12 ALARM EVENT CODE	5	___
133	ZONE TYPE 12 CHARACTERISTIC SELECT	457-125-45678-0-0	___
134	ZONE TYPE 13 ALARM EVENT CODE	4	___
135	ZONE TYPE 13 CHARACTERISTIC SELECT	0-12458-5678-0-0	___
136	ZONE TYPE 14 ALARM EVENT CODE	7	___
137	ZONE TYPE 14 CHARACTERISTIC SELECT	5-12456-5678-0-0	___
138	ZONE TYPE 15 ALARM EVENT CODE	5	___
139	ZONE TYPE 15 CHARACTERISTIC SELECT	457-1256-5678-0-0	___
140	ZONE TYPE 16 ALARM EVENT CODE	4	___
141	ZONE TYPE 16 CHARACTERISTIC SELECT	0-12456-5678-0-0	___
142	ZONE TYPE 17 ALARM EVENT CODE	7	___
143	ZONE TYPE 17 CHARACTERISTIC SELECT	5-1245-25678-0-0	___
144	ZONE TYPE 18 ALARM EVENT CODE	5	___
145	ZONE TYPE 18 CHARACTERISTIC SELECT	457-125-25678-0-0	___
146	ZONE TYPE 19 ALARM EVENT CODE	4	___
147	ZONE TYPE 19 CHARACTERISTIC SELECT	0-1245-25678-0-0	___
148	ZONE TYPE 20 ALARM EVENT CODE	7	___
149	ZONE TYPE 20 CHARACTERISTIC SELECT	6-1245-25678-0-0	___
150	ZONE TYPE 21 ALARM EVENT CODE	15	___
151	ZONE TYPE 21 CHARACTERISTIC SELECT	24-15-78	___
152	ZONE TYPE 22 ALARM EVENT CODE	20	___
153	ZONE TYPE 22 CHARACTERISTIC SELECT	24-15-78	___
154	ZONE TYPE 23 ALARM EVENT CODE	21	___
155	ZONE TYPE 23 CHARACTERISTIC SELECT	24-15-78	___
156	ZONE TYPE 24 ALARM EVENT CODE	22	___
157	ZONE TYPE 24 CHARACTERISTIC SELECT	1-13-378	___
158	ZONE TYPE 25 ALARM EVENT CODE	14	___
159	ZONE TYPE 25 CHARACTERISTIC SELECT	248-45-0-0-0	___
160	ZONE TYPE 26 ALARM EVENT CODE	5	___
161	ZONE TYPE 26 CHARACTERISTIC SELECT	467-125-5678-0-0	___
162	ZONE TYPE 27 ALARM EVENT CODE	5	___
163	ZONE TYPE 27 CHARACTERISTIC SELECT	457-1257-5678-0-0	___
164	ZONE TYPE 28 ALARM EVENT CODE	7	___
165	ZONE TYPE 28 CHARACTERISTIC SELECT	6-12457-5678-0-0	___
166	ZONE TYPE 29 ALARM EVENT CODE	5	___
167	ZONE TYPE 29 CHARACTERISTIC SELECT	457-125-5678-1-0	___
168	ZONE TYPE 30 ALARM EVENT CODE	7	___

LOC	DESCRIPTION	DEFAULT	PROGRAMMING DATA						
169	ZONE TYPE 30 CHARACTERISTIC SELECT	5-1245-5678-1-0	-----						
170-205	RESERVED								
206	DAYS OF THE WEEK "AUTO DISARMING" WILL OCCUR								
	Segment 1	Sunday	Monday	Tuesday	Wednesday	Thursday	Friday	Saturday	Reserved
		1	2	3	4	5	6	7	8

ZONE WORKSHEET

1		5	
2		6	
3		7	
4		8	

NOTES

XV. GLOSSARY

Abort

If enabled, the NX-4V2 will wait the programmed number of seconds in location 40 prior to sending an alarm. During this delay time, the "Cancel" LED will flash. To abort the report, type in a code and press the Cancel key. The LED will extinguish. If the report is not aborted within the allotted time, the LED will extinguish when the report is sent. "Dialer Delay" must be enabled in the "Characteristic Select" of locations 110-169. (Loc 40 & 110-169, pg 19 & 23-27)

AC Fail / Low Battery Report / Warning

The NX-4V2 can be programmed to report AC failure and/or Low Battery conditions to the central station. It can also be programmed to sound the keypad immediately upon detection of the condition. The AC failure report/warning can be delayed. (Loc 37 & 39, pg 17)

AC Power / Low Battery Sounder Alert

If enabled, the NX-4V2 will beep the keypad sounder upon arming or disarming if the AC power is missing or a low battery has been detected. (Loc 23, pg 15)

Arm / Disarm Codes

The NX-4V2 can have 8 four-digit codes or six-digit codes to arm/disarm the control. All codes must have the same number of digits. The factory default for User #1 is ①②③④ when using a 4-digit code, or ①②③④⑤⑥ for a 6-digit code. This code can then be used to enter the new arm/disarm codes. (Loc 41, pg 19)

Automatic Arming

NOTE: This feature must be disabled for UL installations

If programmed, the NX-4V2 will Auto Arm at a specified time. At this time, the keypad will beep for 50 seconds before the panel arms. The arming process will be stopped if a code is entered on the keypad. The NX-4V2 will attempt to arm after every 45 minutes of inactivity until the next "opening" time (loc. 52), or until the system is armed. The 45-minute timer will be extended when there is activity in the building causing the "Ready" LED to turn off and on. If closing reports are sent, the user code will be 97. (Loc 23 & 52-55, pg 15 & 21)

Automatic Bypass / Instant Arming

When enabled, the control panel can automatically bypass interior follower zones if an exit is not detected during the exit delay time. Entry delay zones can also be made instant. (Loc 23, segments 1 & 3, pg 15)

Auto Cancel / Abort

If enabled, the Cancel and/or Abort features will be automatic (pressing the [Cancel] button is not required). The Cancel and Abort features, in locations 23 & 40 respectively, must be enabled to permit this Auto feature to work. For proper operation of these features, "Dialer Delay" must be enabled in the "Characteristic Select" of locations 110-169 Zone Types. (Loc 41, pg 19)

Auto Test

This feature will cause the panel to call the central station to report a communicator test at a specified interval. (Loc 51, pg 20)

Auxiliary Outputs

The NX-4V2 has 2 programmable outputs that can be used to activate relays, LED's, etc. (See the terminal description on pg 6 and Loc 45-50, pg 19)

Auxiliary Power Over-current

The NX-4V2 will illuminate the "Service" LED on the keypad whenever too much current is drawn from any device powered by the system. This condition can be reported to the central station. (Loc 37, pg 17)

Box Tamper

The NX-4V2 has an input for a normally closed tamper switch (see terminal drawing). The Box Tamper can be programmed to report and/or sound the siren and/or the keypad. These terminals can be enabled or disabled in programming. (Loc 37 & 39, pg 17)

Built In Siren Driver

The NX-4V2 has a built-in 112db-siren driver. When desired, this built-in driver can be easily converted to a 1-amp voltage output through programming. (Loc 37, pg 17)

Bypass Toggle

This feature will enable the end user to toggle (turn on or off) the bypass of an interior zone with the system armed by pressing the [Bypass] key. (Loc 23, pg 15)

Call Back

When enabled, the control will use the call back phone number to call the download computer before beginning a download. (Loc 21, pg 15)

Cancel

If enabled, the NX-4V2 will send a "Cancel" report if when the system is disarmed and the [Cancel] button is pressed within 5 minutes of an alarm. Once the [Cancel] key is pressed, the "Cancel" LED will illuminate until the central station acknowledges the "Cancel" report. "Dialer Delay" must be enabled in the "Characteristic Select" of locations 110-149. (Loc 23, pg 15)

Code Required Options

The NX-4V2 can be programmed to require a code for bypassing zones and/or initiating a download using the *⑨⑧ or *⑨⑨ function. (Loc 23 & 41, pg 15 & 19)

Communication Formats

The NX-4V2 can report in multiple formats. It is recommended that you use Contact ID or SIA formats if possible. If you wish to report to a pager or in a 4+2 format to a central station, you must program each code to be reported. (Loc 56-83 & 111-169, pg 22-23 & 23-27)

Cross Zoning

This feature requires two or more trips on a zone or zones programmed as "cross zones" within a specified time before reporting an alarm. During the time between trips, the NX-4V2 can be programmed to sound the keypad and/or the siren. The NX-4V2 can also be programmed to report an alarm after two or more trips on the same zone. (Loc 37, 39, 40 & 110-149, pg 17, 19, 23-27)

Dual / Split / Multiple Reports

The NX-4V2 can send communication reports to three different phone numbers for dual, split or multiple reports selectable by event. (Loc 4, 10, & 16, pg 12, 13, 14)

Duress Code

If a duress code is programmed the NX-4V2 will send a duress signal whenever the panel is armed or disarmed with this code. If open/close reports are sent, the user code will be 254. (Loc 44, pg 19)

Dynamic Battery Test

The NX-4V2 can be programmed to perform a Dynamic Battery Test for a selected duration the first time the panel is armed or disarmed every day, as well as by using *4 (Test function). If the panel is not armed or disarmed during the day, it will perform the test at midnight. The NX-4V2 can also be programmed to perform a missing battery test every 12 seconds. (Loc 37 & 40, pg 17 & 19)

Early to Open / Late to Close

If an opening occurs before the opening and closing times, the NX-4V2 will send an "Early Open" report. If it fails to close on or before the designated closing time, the NX-4V2 will send a "Late to Close" report.

End of Line Resistor Defeat

NOTE: For UL installations, all zones must be programmed as supervised.

The NX-4V2 can be programmed to make zones 1-8 for normally closed operation only, eliminating the need for the end of line resistors on these zones. When a zone is programmed for normally closed operation, a short on that zone will not change the loop condition, and an open on that zone will produce a faulted condition. This feature will be ignored by any Priority zone. (Loc 111-169, pg 23-27)

Entry-Guard

NOTE: For UL installations, this feature shall be disabled.

This unique low level arming mode has been developed to reduce the most common source of false alarms. When armed with the "Instant" LED on, the opening of any zones designated as "Entry Guard zone" will initiate the keypad sounder and start the entry delay before creating an alarm. All other zones will function as normal. This arming mode will encourage system owners to use their system more frequently when the premises are occupied. (Loc 111-169, pg 23-27)

Exit Error

If enabled, the NX-4V2 will send an "Exit Error Report" if an entry/exit zone is faulted at the instant the exit delay expires. This report will be sent along with the user number that armed the system, if the panel is not disarmed before the entry delay expires. The alarm report will also be sent. Even if this feature is not enabled, the siren will sound if any entry/exit zone is faulted at the instant the exit delay expires. (Loc 23, pg 15)

Expander Trouble

The NX-4V2 will report expander trouble to the central station if enabled. This condition will illuminate the "Service" LED on the keypad even if not reported. NOTE: The keypads are considered expanders. The expansion device number that will report can be found on page 41. (Loc 37, pg 17)

Fail to Communicate

The NX-4V2 will illuminate the "Service" LED if a report fails to reach the central station. If enabled, when the next report is successfully communicated, a Fail to Communicate code will be reported. (Loc 37, pg 17)

Fire Alarm Verification

When enabled, the NX-4V2 will verify a Fire alarm by requiring more than one trip on a smoke detector within a specified time before creating an alarm. (Loc 40, pg 19) **This feature is not approved for residential use in California.**

First to Open / Last to Close

The first partition that opens from a completely armed system (all valid partitions armed) will send an "Open" report. All other partitions opened will be *log only*. The last partition to close from a completely armed system (all valid partitions armed) will report to the central station. Any prior closing(s) will be *log only*. (Loc 37, pg 17)

Force Arming

NOTE: For UL installations, this feature shall be disabled.

When enabled, the NX-4V2 can be Force Armed with zones violated. Under this condition, if a force armable zone is not secure, the "Ready" LED will flash. At the end of the exit delay, these zones will become bypassed. If these zones become secured any time during the arming cycle, they will be unbypassed and active in the system. If "Bypass Report" is enabled, the force arming zones can be programmed to report bypass when they are Force Armed (default), or to not report bypass even if "Bypass Report" is enabled. (Loc 37 & 111-169, pg 17 & 23-27)

Group Bypass

NOTE: For UL installations, this feature shall be disabled.

A designated group of zones can be programmed to bypass by pressing [Bypass]-[0]-[Bypass]-[Bypass] prior to arming. (Loc 111-169, pg 23-27)

Immediate Restore By Zone

The NX-4V2 can be programmed to send alarm and restore reports as soon as they occur, or wait until the siren time has expired. (Loc 37, pg 17)

Internal Event Log

Up to 512 events can be stored in memory along with the date and time of the event. These events can later be viewed through downloading. **All reportable events report to the log.**

Keypad Activated Panics

The NX-4V2 has three keypad activated panics that will send reports to the central station: Auxiliary 1 (Fire), Auxiliary 2 (Medical), and Keypad Panic. Auxiliary 1 will activate the steady (Fire) siren, Auxiliary 2 will sound the keypad, and the Keypad Panic can be programmed to be silent or audible (sound siren). (Loc 23, pg 15)

Keypad Sounder Control

The NX-4V2 can be programmed to sound the keypad sounder for certain events. (Loc 39, pg 18)

Keypad Tamper

If enabled, the NX-4V2 will disable the keypad for 60 seconds and communicate a tamper signal to the central station if 30 keypresses are entered without producing a valid code. (Loc 23, pg 15)

Keyswitch Arm/Disarm

Any zone on the NX-4V2 can be programmed as a keyswitch zone. If this is done, a momentary short on this zone will arm/disarm the control. If opening/closing reports are sent, the user code will be 99. (See "Default Zone Types", pg 16)

LED Extinguish

This feature will extinguish all LEDs on the keypad, except the "Power" LED, after 60 seconds without a keypress. Pressing any numeric key will illuminate all LED's. **(Loc 23, pg 15)**

Local Programming Lockout

This feature will disable programming of all locations or specified locations from the keypad. **(Loc 21, pg 15)**

Log Full Report

A report can be sent to the central station when the event log is full. **(Loc 37, pg 17)**

Lost Clock Service Light

The NX-4V2 can be programmed to illuminate the "Service" LED when the internal clock has an invalid time due to power loss. **(Loc 37, pg 17)**

Manual Test

The NX-4V2 can be programmed to perform a bell and/or communicator test when *④④ is entered while the system is in the disarmed state. **(Loc 37, pg 17)**

Night Mode

NOTE: This mode applies to NX1208E / NX1248E keypads.

In this mode, the control panel will bypass all zones that have the Entry Guard feature enabled. **(Loc 23, pg 15)**

On Board Zone Disable

The 4 zones on the NX-4V2 panel can be disabled in order to have a completely wireless alarm system. **(Loc 37, pg 17)**

Program Code

The factory default for the "Go To Program" code is ⑨⑦①③ when using a 4-digit code or, if the 6-digit option is used, the default is ⑨⑦①③①①. The program code can also be used as an Arm/Disarm code. If used as an Arm/Disarm code, and open/close reports are sent, the user code will be 255. **(Loc 43, pg 19)**

Quick Arm Feature

The NX-4V2 has a one-button "Quick Arm" feature which can be used to arm the system by pressing the [Exit] key or the [Stay] key on the keypad. If closing reports are sent, the user code will be 98. **(Loc 23, pg 15)**

Recent Closing

If enabled, the NX-4V2 will send a "Recent Closing Report" to the central station if an alarm occurs within 2 minutes after the panel is armed. The user number that armed the system will also be sent. **(Loc 23, pg 15)**

Re-exit

The NX-4V2 has the ability to restart the exit delay for a quick exit without disarming the system by pressing the [Exit] key while the system is armed. **(Loc 23, pg 15)**

Shutdown

When enabled, the keypads will turn off all LED's, except the "Power" LED, and not accept keypresses. **(Loc 21, pg 15)**

Siren Blast For Arming

The NX-4V2 can be programmed to give a one-second siren blast when the panel is armed, at the end of the exit delay, or when the central station receiver acknowledges the closing report. It can also give one blast for remote (keyswitch) arming and two blasts for remote disarming. **(Loc 37, pg 17)**

Siren Supervision

The NX-4V2 has a "Siren Supervision" circuit that will constantly monitor the siren on the NX-4V2 and can be programmed to report if the wires are cut. **(Loc 37, pg 17)**

Silent Exit Option

The exit delay can be silenced by pressing [*]-[Exit] before arming the control panel or when using the re-exit feature.

Start / End Programming and End Downloading

A report can be sent when local programming is started and ended. A report can also be sent when a download session ends. **(Loc 37, pg 17)**

Swinger Shutdown

This feature allows a zone or zones to be automatically bypassed after a specified number of alarms. When a zone is tripped, the alarm 'counter' reflects "1" in memory. If a new (first) alarm is detected in a different zone, the counter remains at "1". If an alarm is detected on a previously tripped zone, the count increments to "2". The 'counter' will increment each time an alarm is detected on a zone with multiple trips. Bypassing will occur on the zone that causes the count to equal the number programmed in location 38; the 'counter' will reset to zero (0); and begin a new trip count where the next alarm will set the 'counter' to 1. If immediate restore is enabled in location 37, the alarms (and restores, if enabled) will be sent as they occur. If immediate restore is not enabled, a second or subsequent alarm will not be sent until the siren times out. **Factory default is 1. (Loc 37 & 38, pg 17)**

Telephone Line Monitor

The NX-4V2 has a Telephone Line Monitor that monitors the voltage and current of the telephone line for a detection of a faulted phone line. This condition can also be reported to the central station. If the report is enabled, only the Telephone Line Restore will be reported. **(Loc 37, 39, & 40, pg 17-19)**

Temporal Siren Disable

NOTE: For UL installations, do NOT disable.

If disabled, the Fire Siren will be steady and Fire Voltage Out will be the same as Burglary (continuous). Otherwise, the Fire Siren will be temporal. **(Loc 37, pg 17)**

Tone Sniff Answering Machine Defeat

If enabled, only one call is required to defeat the answering machine. To use this feature you must have a Hayes 1200 Smart Modem. From the computer, call the panel as normal. When the answering machine answers, the panel will hear the tones from the modem and seize the phone line for a download. **(Loc 21, pg 15)**

Two Call Answering Machine Defeat

This is not recommended for commercial applications.

If enabled, to defeat an answering machine, two telephone calls must be made to the premises. On the first call, let the phone ring one or two times. The control panel will detect these rings and start a 45-second timer, during which, the control panel will answer the next call on the first ring. **(Loc 21, pg 15)**

Walk-Test Mode

If enabled, entering [*] [Chime] followed by a user code will allow a walk-through zone test where all zones become silent and local (non-reporting). During this test the chime light will flash on the LED keypad. Each time a zone is faulted, the zone light on the LED keypad will illuminate and the chime will sound. The number of the faulted zone(s) will be displayed on the LCD keypad. It will also be entered into alarm memory and the internal log. To exit at any time during this mode, enter a user code. Otherwise the "Walk-Test Mode" will automatically exit after 15 minutes. **(Loc 41, pg 19)**

Wireless Sensor Missing/Low Battery

The NX-4V2 will send a report to the central station when a wireless sensor has detected a low battery or has not reported to the receiver. The "Service" LED will illuminate when either condition exists. **(Loc 37, pg 17)**

Zone Activity Monitor

This feature will send a report to the central station when a particular zone does not change conditions within the specified number of days programmed. **(Loc 40 & 110-169 pg 19 & 23-27).**

Zone Bypassed Sounder Alert

If this feature is enabled, the NX-4V2 will beep the keypad sounder upon arming if a zone is bypassed. **(Loc 23, pg 15)**

Zone Doubling

Zone doubling can only be enabled when at least one other device is added to the basic system (consisting of the main control panel and one keypad). Additional devices can include wireless receivers, extra keypads, etc. If enabled, this feature allows you to use the four zones on the panel as eight normally closed zones. When this feature is used, European double E.O.L. configuration cannot be used.. **THIS FEATURE DOES NOT INCREASE THE TOTAL NUMBER OF AVAILABLE ZONES BEYOND 8.** If one of the eight zones must be a fire zone, it must be one of Zones 1 to 4. The corresponding upper zone will become unavailable. For example: if Zone 4 is a fire zone, then Zone 8 will not be available. **(Loc 37, pg 17)**

Zone Types (Configurations)

The NX-4V2 has 30 programmable Zone Types that determine how each zone will function and report. The default Zone Types are listed on page 16. **(Loc 111-169, pg 23-27)**

XVI. APPENDIX 1

REPORTING FIXED CODES IN CONTACT ID AND SIA

The table below list the event codes sent for the following reports (if enabled) when using CONTACT ID or SIA formats.

REPORT	CONTACT ID	SIA
AC FAIL (device number)	301.....	AT
AC RESTORE (device number).....	301.....	AR
AUTOTEST.....	602.....	RP
AUX POWER OVER CURRENT (device number)	312.....	YP
AUX POWER RESTORE (device number).....	312.....	YQ
BOX TAMPER (device number)	137.....	TA
BOX TAMPER RESTORE (device number)	137.....	TR
BYPASS RESTORE (zone number).....	570.....	*U
CANCEL (user number).....	406.....	OC
CLOSE (user number)	401.....	CL
DOWNLOAD COMPLETE	412.....	RS
DURESS.....	121.....	HA
EARLY OPEN/LATE CLOSE.....	451.....	OK
END PROGRAM.....	628.....	LX
EVENT LOG FULL	605.....	JL
EXIT ERROR (user number)	457.....	EE
EXPANDER RESTORE (device number)	333.....	ER
EXPANDER TROUBLE (device number)	333.....	ET
FAIL TO CLOSE	454.....	CI
FAIL TO COMMUNICATE	354.....	RT
FORCED DOOR.....	423.....	DF
FORCED DOOR RESTORE.....	423.....	DR
GROUND FAULT	310.....	GF
GROUND FAULT RESTORE	310.....	GK
KEYPAD AUXILIARY 1.....	110.....	FA
KEYPAD AUXILIARY 2.....	100.....	MA
KEYPAD PANIC (audible)	120.....	PA
KEYPAD PANIC (silent).....	121.....	HA
KEYPAD TAMPER	137.....	TA
LOW BATTERY (device number)	309.....	YT
LOW BATTERY RESTORE (device number)	309.....	YR
MANUAL TEST.....	601.....	RX
OPEN (user number)	401.....	OP
RECENT CLOSE (user number)	401.....	CR
RF SENSOR LOST (zone number)	381.....	*T
RF SENSOR RESTORE (zone number)	381.....	*R
SENSOR BATTERY RESTORE (zone number).....	384.....	XR
SENSOR LOW BATTERY (zone number).....	384.....	XT
SIREN RESTORE (device number).....	321.....	YH
SIREN TAMPER (device number)	321.....	YA
START PROGRAM.....	627.....	LB
TELEPHONE FAULT.....	351.....	LT
TELEPHONE RESTORE.....	351.....	LR
ZONE ACTIVITY FAULT	391.....	NA
ZONE ACTIVITY RESTORE	391.....	NS
ZONE BYPASS (zone number)	570.....	*B
ZONE TAMPER (zone number).....	137.....	TA
ZONE TAMPER RESTORE (zone number)	137.....	TR
ZONE TROUBLE (zone number).....	380.....	*T
ZONE TROUBLE RESTORE (zone number)	380.....	*R

THE NUMBER IN PARENTHESES FOLLOWING THE EVENT IS THE NUMBER THAT WILL BE REPORTED AS THE ZONE NUMBER. IF THERE ARE NO PARENTHESES, THE ZONE WILL BE "0". SEE PAGE 41 FOR THE DEVICE NUMBERS.

* The character transmitted in this slot will be the first character from the event code of the zone that is bypassed or in trouble. (See locations 110 - 141)

XVII. APPENDIX 2

REPORTING ZONE CODES IN SIA OR CONTACT ID

The NX-4V2 has the ability to report SIA level 1 transmissions to either or both phone numbers. Each report in SIA consists of an Event Code and a Zone or User ID. The Zone ID will be the zone number that is in alarm. The event code will come from the chart below and be programmed in the zone type event code.

Programmed Event Code	SIA Code	Description
0	HA	Holdup Alarm
1	FA	Fire Alarm
2	PA	Panic alarm
3	BA	Burglary Alarm
4	BA	Burglary Alarm
5	BA	Burglary Alarm
6	UA	Untyped Alarm
7	BA	Burglary Alarm
8	BA	Burglary Alarm
9	UA	Untyped Alarm
10	HA	Holdup Alarm
11	MA	Medical Alarm
12	PA	Panic alarm
13	TA	Tamper Alarm
14	RP	Periodic Test
15	GA	Gas Alarm
16	KA	Heat Alarm
17	WA	Water Alarm
18	QA	Emergency Alarm
19	SA	Sprinkler Alarm
20	ZA	Freeze Alarm
21	KH	High Temp Alarm
22	FA	Manual Fire Alarm

The NX-4V2 has the ability to report Ademco Contact ID transmissions. Each report in Contact ID consists of an Event Code and a Zone ID. The zone ID is the zone that created the alarm. The event code will come from the chart below and be programmed in the zone type event code.

Programmed Event Code	Contact ID Code	Description
0	122	Silent Panic
1	110	Fire Alarm
2	120	Panic alarm
3	130	Burglary Alarm
4	131	Perimeter Alarm
5	132	Interior Alarm
6	133	24 Hour Burglary
7	134	Entry Alarm
8	135	Day/Night Alarm
9	150	Non Burglary 24 Hour
10	121	Duress Alarm
11	100	Medical Alarm
12	123	Audible Panic Alarm
13	137	Tamper Alarm
14	602	Periodic Test
15	151	Gas Detected
16	158	High Temp
17	154	Water Leakage
18	140	General Alarm
19	140	General Alarm
20	159	Low Temp
21	158	High Temp Alarm
22	115	Manual Fire Alarm

XVIII. APPENDIX 3

EXPANDER NUMBERS FOR REPORTING EXPANDER TROUBLE

The tables below list the device numbers that will be reported for trouble conditions.

Device	Device # reported
NX-4V2 Control Panel	0
NX-534E Two Way Listen-In	64
NX-540E "Operator"	40
NX-591E Cellemetry Interface	76

See page 39 for possible report codes.

KEYPADS

KEYPAD	DEVICE #
1	192
2	200
3	208
4	216
5	224
6	232
7	240
8	248

REMOTE POWER SUPPLY (NX-320E)

Switch Setting	Address
All switches off	84
Switch 1 on	85
Switch 2 on	86
Switch 1 & 2 on	87
Switch 3 on	88
Switch 1 & 3 on	89
Switch 2 & 3 on	90
Switches 1, 2, & 3 on	91

WIRELESS RECEIVER (NX-448E)

Switch Setting	Expander # reported
All switches off	35
Switch 1 on	36
Switch 2 on	37
Switches 1 & 2 on	38
Switch 3 on	39
Switches 1 & 3 on	32
Switches 2 & 3 on	33
Switch 1, 2 & 3 on	34

OUTPUT MODULE (NX-508E)

Switch Setting	Address
Switch 1 & 2 on	24
Switch 3 on	25
Switch 1 & 3 on	26
Switch 2 & 3 on	27
Switch 1,2,&3 on	28
All switches off	29
Switch 1 on	30
Switch 2 on	31

XIX. APPENDIX 4

USER ID OR ZONE ID HEX DIGIT FOR 4+2 FORMATS

The following appendix applies only to slow formats (locations 56- 83 lower digit). The digit programmed in the locations will be sent as the upper HEX digit in place of the alarm event code. The zone ID or user ID will always be reported as the lower HEX digit (1-F) as shown in the chart below. For example, if the zone ID or user ID is 6, the 4+2 lower digit will be "6". Use the chart shown below for convenience.

 If Segments 2-8 are left as "0" (unprogrammed), they will follow the Segment 1 selection. If Segment 1 is left as "0" and the feature is enabled in Location 23, the NX-4V2 will report "A".

ZONE	HEX
USER	
1	1
2	2
3	3
4	4
5	5
6	6
7	7
8	8

XX. LOCAL TELEPHONE COMPANY INTERFACE INFORMATION

TELEPHONE CONNECTION REQUIREMENTS

Except for telephone company provided ringers, all connections to the telephone network shall be made through standard plugs and standard telephone company provided jacks or equivalent in such a manner as to allow for immediate disconnection of the terminal equipment. Standard jacks shall be so arranged that if the plug connected thereto is withdrawn, no interference to the operation of the equipment at the customer's premises, which remains connected to the telephone network, shall occur by reason of such withdrawal.

INCIDENCE OF HARM

Should terminal equipment or protective circuitry cause harm to the telephone network, the telephone company shall, where practical, notify the customer that temporary discontinuance of service may be required. However, where prior notice is not practical, the telephone company may temporarily discontinue service if such action is deemed reasonable in the circumstances. In the case of such temporary discontinuance, the telephone company shall promptly notify the customer who will be given the opportunity to correct the situation. The customer also has the right to bring a complaint to the FCC if he feels the disconnection is not warranted.

CHANGES IN TELEPHONE COMPANY EQUIPMENT OR FACILITIES

The telephone company may make changes in its communications facilities, equipment, operations, or procedures where such action is reasonably required and proper in its business. Should any such change render the customers terminal equipment incompatible with the telephone company facilities, the customer shall be given adequate notice to make modifications to maintain uninterrupted service.

GENERAL

The FCC prohibits customer-provided terminal equipment to be connected to party lines.

IMPORTANCE OF THE RINGER EQUIVALENCE NUMBER

The Ringer Equivalence Number (REN) of this device is 0.1B. This number is a representation of the electrical load that it applies to your telephone line.

MALFUNCTION OF THE EQUIPMENT

In the event that the device should fail to operate properly, the customer shall disconnect the equipment from the telephone line to determine if it is the customers' equipment that is not functioning properly. If the problem is with the device, the customer shall discontinue use until it is repaired.

EQUIPMENT INFORMATION

Manufacturer Of Connecting Equipment: **CADDX CONTROLS, INC.**

FCC Registration Number: **US:GCQAL01BNX-V2**, RINGER EQUIVALENCE: 0.1 B

XXI. INDUSTRY CANADA INFORMATION

NOTICE: The Industry Canada label identifies certified equipment. This certification means that the equipment meets telecommunications network protective, operational and safety requirements as prescribed in the appropriate Terminal Equipment Technical Requirements document(s). The Department does not guarantee the equipment will operate to the user's satisfaction.

Before installing this equipment, users should ensure that it is permissible to be connected to the facilities of the local telecommunications company. The equipment must also be installed using an acceptable method of connection. The customer should be aware that compliance with the above conditions might not prevent degradation of service in some situations.

Repairs to certified equipment should be coordinated by a representative designated by the supplier. Any repairs or alternations made by the user to this equipment, or equipment malfunctions, may give the telecommunications company cause to request the user to disconnect the equipment.

Users should ensure for their protection that the electrical ground connections of the power utility, telephone lines and internal metallic water pipe system, if present, are connected together. This precaution may be particularly important in rural areas.

Caution: Users should not attempt to make such connections themselves, but should contact the appropriate electrical inspection authority, or electrician, as appropriate.

The Ringer Equivalence Number (REN) of this device is 0.1B. This number is a representation of the electrical load that it applies to your telephone line. **NOTICE:** The Ringer Equivalence Number (REN) assigned to each terminal device provides an indication of the maximum number of terminals allowed to be connected to a telephone interface. The termination on an interface may consist of any combination of devices subject only to the requirement that the sum of the Ringer Equivalence Numbers of all the devices does not exceed 5.

XXII. NOTICES

(Applies to products which have the CE mark attached)

Declaration Of Conformity

Manufacturer's Name: Caddx Controls
Manufacturer's Address: 1420 North Main Street
Gladewater Texas 75647

EU Representative: Interlogix Europe

Product Identification

Product: NetworX
Model Numbers: NX-4V2
Brand: CADDX

R&TTE Directive

See EMC and LVD tests below

EMC Directive

EN50081-1
EN50130-4
EN55022
EN60950
EN61000-3-2
EN61000-3-3

LVD Directive

EN 60950: 1999-4 3rd edition

Means of Conformity

We declare under our sole responsibility that this product is in conformity with Directive 1999/5/EC (R&TTE); Directive 73/23/EEC (LVD); and Directive 89/336/EEC (EMC) and based on test results using (non)-harmonized standards in accordance with the Directives mentioned.

Additional Tests

This equipment has been tested and found to comply with the following standards (which are no longer required for compliance).

Network Compatibility Declaration

We declare under our sole responsibility that this product is designed to work with the networks in the countries marked with a check (✓) and may have interworking problems with the countries that are not checked. Due to the inherent differences in the individual PSTNs, certain software settings may need to be adjusted on a country-to-country basis. If it is desired to use this equipment on a network other than the one on which it was originally installed, you should contact your equipment supplier.

<input checked="" type="checkbox"/> Austria	<input type="checkbox"/> Liechtenstein
<input checked="" type="checkbox"/> Belgium	<input checked="" type="checkbox"/> Luxembourg
<input checked="" type="checkbox"/> Denmark	<input checked="" type="checkbox"/> Netherlands
<input checked="" type="checkbox"/> Finland	<input checked="" type="checkbox"/> Norway
<input checked="" type="checkbox"/> France	<input checked="" type="checkbox"/> Poland
<input checked="" type="checkbox"/> Germany	<input checked="" type="checkbox"/> Portugal
<input checked="" type="checkbox"/> Greece	<input checked="" type="checkbox"/> Spain
<input checked="" type="checkbox"/> Iceland	<input checked="" type="checkbox"/> Sweden
<input checked="" type="checkbox"/> Ireland	<input checked="" type="checkbox"/> Switzerland
<input checked="" type="checkbox"/> Italy	<input checked="" type="checkbox"/> United Kingdom

Telecom Approval Notice

This equipment has been approved in accordance with the Council Decision 98/482/EC for pan-European, single terminal connection to the public switched telephone network (PSTN). However, due to the differences between the individual PSTNs provided in different countries, the approval does not, of itself, give an unconditional assurance of successful operation on every PSTN network termination point. In the event of problems, you should contact your equipment supplier in the first instance.

Electrical Requirements

This device automatically adjusts to voltages within the range of 230 V 50/60 Hz.

Fuse: Type T 200mA 250 VAC

XXIII. UNDERWRITERS LABORATORIES INFORMATION

The NetworX NX-4V2 holds the following listings from Underwriters Laboratories (US and Canadian):

UL294	Access Control System Units
UL365	Police Station Connected Burglar Alarms
UL609 CAN/ULC-S303-M91	Local Grade A Mercantile, Police Station Connect with Basic Line Security * requires #NX-003-C enclosure
UL985 CAN/ULC-S545-M89	Household Fire
UL1023 ORD-C1023-1974	Household Burglary
UL1610 CAN/ULC-S304-M88	Grade B & C Central Station Burglar Alarm Unit
UL1635	Digital Alarm Communicator System Units
UL1637	Home Health Care Signaling

WHEN INSTALLING AN NX-4V2 IN COMPLIANCE WITH UNDERWRITERS LABORATORIES, THE FOLLOWING INSTRUCTIONS MUST BE OBSERVED:

- Initiating and indicating devices must be rated at 11.5 to 12.4 V DC residential, 12.0 V DC commercial.
- Force Arming and Auto Arming shall not be enabled.
- For residential fire applications, the indicating devices shall be a Wheelock 34T-12 or equivalent.
- The "Listen-In" feature shall not be enabled.
- The Siren/Bell Test shall be enabled. The auxiliary outputs controlling the audible device require a minimum cutoff time of 15 minutes for commercial burglary, 4 minutes for residential applications, or 30 minutes for Commercial Burglary for Canada.
- For residential fire installations, the Dynamic Battery Test time cannot exceed four (4) hours.
- Ringback shall be enabled on UL commercial burglary installations.
- On commercial burglary installations, the fire initiating circuits shall not be connected.
- The Entry-Guard feature shall be disabled.
- Group Bypassing shall be disabled.
- Delay before dial seizure shall be set to "0".
- Total current draw from aux power connections at terminal positions POS, AUX PWR, and SMOKE PWR must not exceed 400 mA.
- Remote Downloading shall not be used on UL listed systems.
- For residential burglary applications, the maximum entry and exit delay times shall be 45 and 60 seconds respectively. The exit delay time shall not exceed 60 seconds for commercial burglar alarm applications.
- The keyswitch option shall not be used.
- The telephone line monitor shall be enabled.
- The Telephone Line Cut delay shall not exceed 90 seconds.
- 24-hour communicator test transmission is required.
- For 24 hours of standby power using a 7.0 AH battery, limit auxiliary power load to 140 mA.
- For 24 hours of standby power using a 17.2 AH battery, limit auxiliary power load to 400 mA.
- The silent keypad option shall not be enabled.
- UL has only verified compatibility with the following listed DACRs and formats: Sure-Gard SG-MLR2-DG: 2,9,10,12,13,14; Silent Knight 9000 - 2,12; FBI - CP220FBI, 13; and Ademco 685: 2,11,12, and 13.
- For burglary installations, cross-zoned detectors shall overlap 100 percent in the area of coverage and similar coverage areas must be used. For example, interior protection is cross-zoned with interior protection, and so on.
- Expander trouble must activate the siren (Loc. 37, Segment 2, LED 2)
- For UL 1637, expander trouble must activate keypad sounder (Loc. 39, Segment 1, LED 8)
- If the Late to Close/Early to Open feature is enabled, the Opening and Closing reports shall be enabled (Loc. 23, Seg. 4, Option 1 and Loc. 23, Seg. 3, Option 1).
- For Canadian installations, the class II transformer secure tab shall not be employed.
- The 4-wire smoke detector employed shall be rated to operate over the voltage range of 11.5 to 12.4V.
- Compatible listed devices: (Special Applications)
 - Bell Output (Sirens): Wheelock models: NS-1215W, NS-121575W, NS4-1215W, NS4-121575W, AS-1215W, AS-121575W
 - Horn / Strobe: System Sensor: S1224MC Strobe series; 1224MC Horn/Strobe series; H12/24 Horn series
 - Smoke Output (4 wire detectors):
 - ESL: 500N series; 449CTE series; 521 series; 541 series
 - System Sensor models: 2112/24R; 2112/24TR; 2112/24AT; 2112/ATR; 2112/24AITR; 4WTA-B; 4WTR-B; 4WTAR-B; 4WITAR-B.
 - Detection Systems: F220-B6C; D273 series
 - Hochiki: SBC-4/12, 4/12W

MINIMUM SYSTEM CONFIGURATIONS FOR UL INSTALLATIONS

(Residential Fire, Residential Burglary, Commercial Burglary)

- The NetworX NX-4V2 panel is necessary to initiate Residential and Commercial installations.
- At least one compatible keypad is needed for all applications.
- At least one bell fixture is required for all applications, except Grade C Central Station. For Grade A Local, the AD10-12 bell and Grade A bell housing shall be used.
- Commercial UL applications require #NX-003-C metal enclosure. Supplied screws to be used.
- A minimum of two (2) keypads is required for Home Health applications and each keypad must be set to a unique address.
- The wireless devices are only UL listed for residential applications.
- The DACT shall be enabled for all commercial burglary applications.

STANDBY TIME	TOTAL AUXILIARY CURRENT	STANDBY BATTERY CAPACITY	ALARM CURRENT
24 hours	1.9 Amps	51 AH	600 mA
	1.25 Amps	34 AH	1 Amp
	600 mA	17 AH	1 Amp
48 hours	900 mA	51 AH	1 Amp
	600 mA	34 AH	1 Amp
	300 mA	17 AH	1 Amp
72 hours	600 mA	51 AH	1 Amp
	400 mA	34 AH	1 Amp
	200 mA	17 AH	1 Amp

Calculations based on three 17-Amp batteries.



IMPORTANT!

If separate power supplies are necessary to accommodate additional devices, safety standards require that each power supply be prominently marked with adequate instructions for removing all power from the unit.

Dispose of used batteries according to the manufacturer's instructions and/or local government authorities.

Installation personnel should thoroughly read and understand the installation instructions and the users manuals for the panel and all the accessories to be included with the system before attempting to install a security system.



WARNING!

Replace only with Panasonic #LC12V4BP or Yuasa #NP4-12 battery. Observe polarity when installing a new battery. Installing the battery backwards may cause damage to the panel. There is a risk of explosion if the battery is replaced with an incorrect type.

NOTE

Electrical codes will vary depending upon the country and city where the system is installed. It is the installer's responsibility to ensure that the electrical installation is safe and conforms to all applicable codes, laws, or regulations. Only qualified persons should connect this device to the mains supply.

XXIV. ANSI / SIA CP-01 REQUIREMENTS

To meet SIA CP-01 requirements –

- Minimum System Requirements: 1 control panel; 2 keypads
- Remote arming shall NOT be enabled in SIA classified installations.
- Off-premise transmission must be in the SIA format.
- The Abort window and Entry Delay must not exceed 1 minute.
- CAUTION – A call waiting cancel on a non-call waiting line will prevent successful connection to the central station.

IMPORTANT NOTE:
UL requirements take priority over SIA requirements.

CP-01 Feature Description	Feature Description as shown in manual	Program Loc	Seg / Opt	Factory Default	CP-01 Required Setting
Exit Time	Exit 1 Delay Exit 2 Delay	24 24	2 4	60 60	45 – 240 sec. 45 – 240 sec.
Progress Annunciation / Disable – for Silent Exit	Silent Keypad Option	* 9 3	2	All annunciators enabled	Allowed (individual keypads may be disabled)
Exit Time Restart	This feature is non-programmable in the panel.				Enabled
Auto Stay Arm on Unvacated Premises	Auto Bypass	23	1 / 3	Enabled	Enabled
Exit Time and Progress Annunciation / Disable – for Remote Arm	This feature is non-programmable in the panel. -- Exit time and progress are always enabled.				Enabled (may be disabled for remote arming)
Entry Delay(s)	Entry 1 Delay Entry 2 Delay	24 24	1 3	30 30	30 – 240 sec. 30 – 240 sec.
Abort Window – for Non-Fire Zones	Dialer Delay	40	8	30	Enabled (may be disabled by zone/ zone type)
Abort Window Time – for Non-Fire Zones	Dialer Delay	40	8	30	15 – 45 sec.
Abort Annunciation	This feature is non-programmable in the panel. -- Flashing Cancel LED goes off when disarming.				Enabled
Cancel Annunciation	Cancel	23	3 / 6	Enabled	Enabled
Duress Feature	Duress	44		Disabled	Disabled
Cross Zoning	2 Trips on Cross Zone	37	5 / 4	Disabled	Required
	Keypad sounds on Cross Zone trip	39	5	Disabled	
	Zone Type Characteristic	111	3 / 4	Disabled	
Programmable Cross Zoning Time	Cross Zone Time	40	6	5 minutes	Allowed
Swinger Shutdown	Swinger Shutdown Count	38	n/a	Enabled for 1 trip	For all non-fire zones, shut down at 1–2 trips
Swinger Shutdown Disable	Swinger Shutdown Count	38	n/a	Enabled for 1 trip	Allowed
Fire Alarm Verification	Fire Alarm Verification Time	40	9	Disabled	Required (depends on panel & sensors)
Call Waiting Cancel	Must be programmed as part of the phone number	0	n/a	n/a	Required (depends on user phone line)
Default Changes (from prior versions):					
	Recent Closing	23	3 / 7	Enabled	
	Exit Error	23	3 / 8	Enabled	
	Power Up Delay	40	3	60 sec.	

NOTES

XXV. SPECIFICATIONS

OPERATING POWER	16.5 VAC 40, or 50 VA Transformer
AUXILIARY POWER w/25 VA Transformer w/40 or 50 VA Transformer	12 VDC Regulated 500 mA 12 VDC Regulated 1 AMP
LOOP RESISTANCE Standard Loop	300 Ohms Maximum
BUILT-IN SIREN DRIVER	2-tone (Temporal and Yelp)
LOOP RESPONSE	Selectable 50mS or 500mS
OPERATING TEMPERATURE	32 to 120 degrees F
LED KEYPAD Current Draw Zones Normal w/o Sounder Dimensions	130 mA max. 55 mA 6.4" Wide 4.0" High 1.1" Deep
NX148E LCD KEYPAD Current Draw w/o Sounder Dimensions	110 mA max. 75 mA 6.4" Wide 5.3" High 1.0" Deep
METAL ENCLOSURE DIMENSION	9.25" Wide 8.25" High 3.50" Deep
SHIPPING WEIGHT	9 lbs.



Main 800-727-2339
Outside the US 903-845-6941
Main Fax 903-845-6811
Web: www.gesecurity.com

Technical Support 888-437-3287
Sales & Literature 800-547-2556